

CIVIC TABLE STD

FFSB003017 - 1800mm TABLE STANDARD - BOLT DOWN

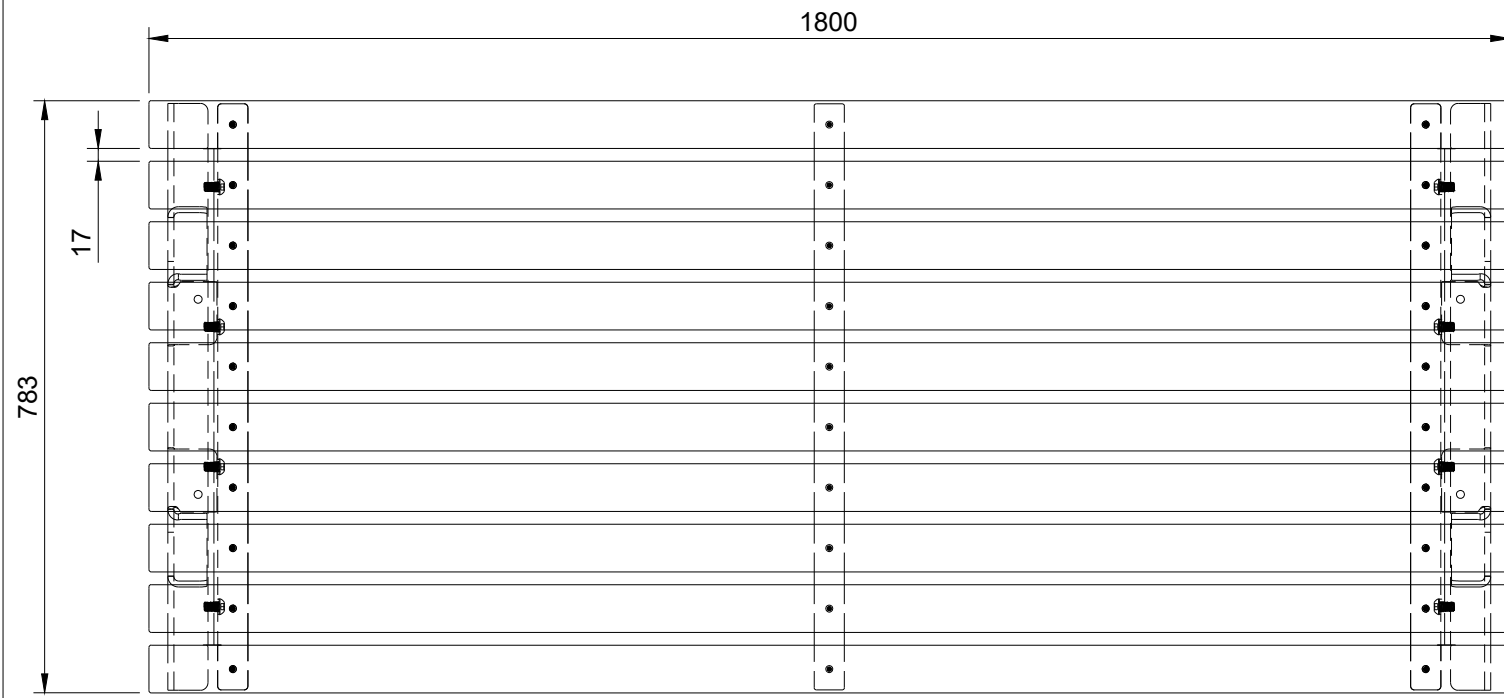

TOP VIEW

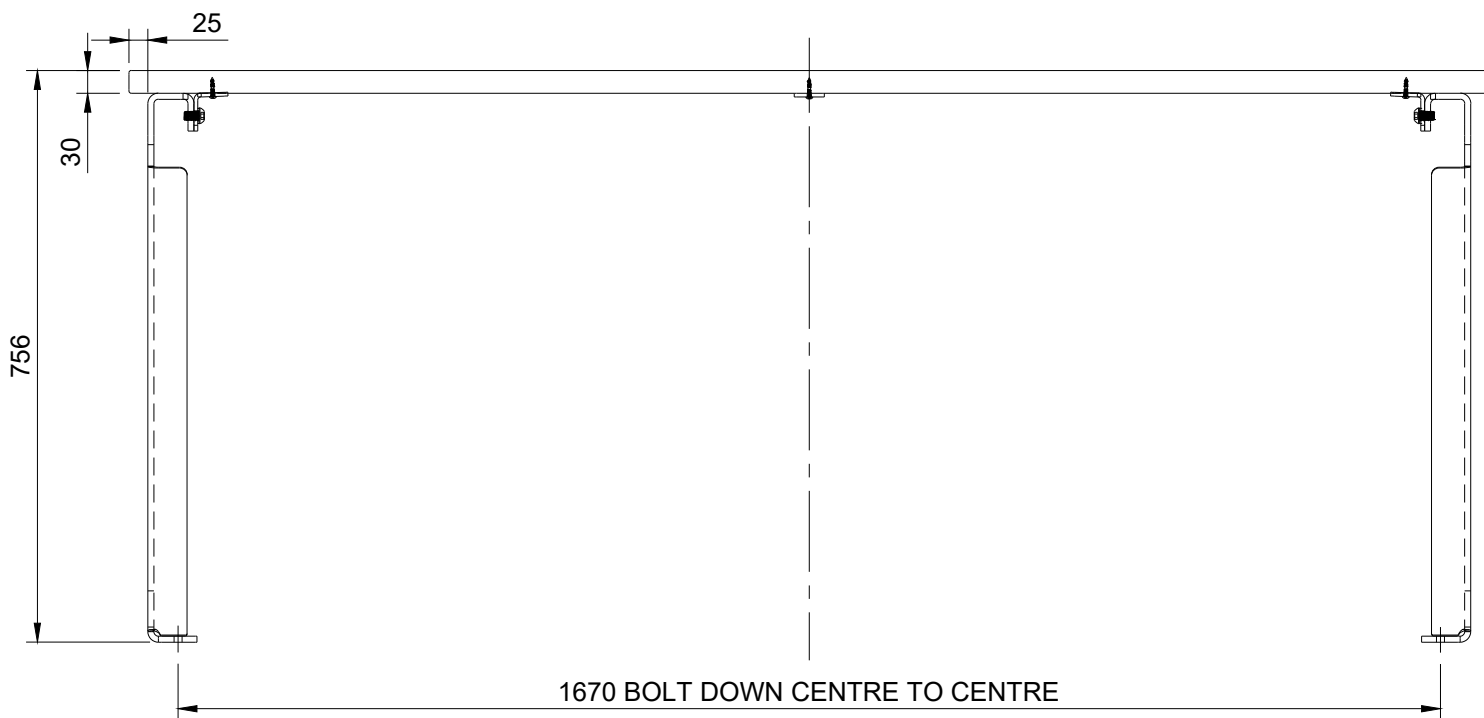

FRONT VIEW

SPECIFICATIONS SLATS			
CODE	MATERIAL SLATS	FINISH SLATS	MATERIAL FIXINGS
FFSB003017	HARDWOOD TIMBER	STANDARD STAIN	STAINLESS STEEL
FFSB003017A	ALUMINIUM	CLEAR ANODISED	STAINLESS STEEL
FFSB003017APC	ALUMINIUM	POWDER COATED	STAINLESS STEEL
FFSB003017ATE	ALUMINIUM	TIMBER EFFECT	STAINLESS STEEL

**PACKAGING
OPTIONS (2)**
1:20

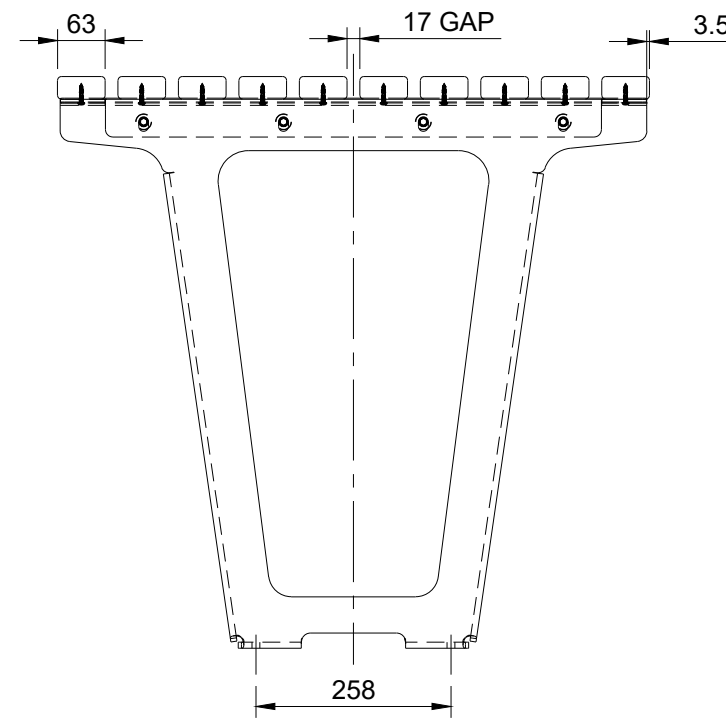
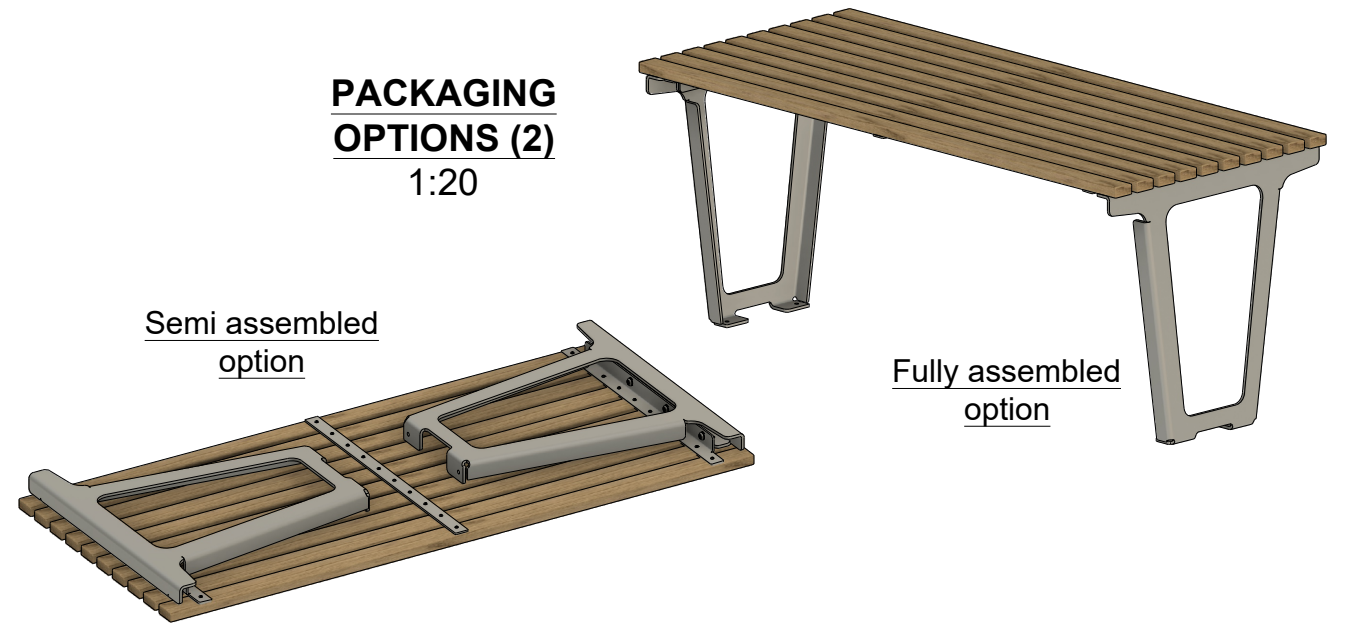

BD CENTRE TO CENTRE
SIDE VIEW

SPECIFICATIONS:

MAIN CONSTRUCTION

MATERIALS:



- Legs - Mild Steel
- Brackets - Stainless Steel 304

FINISH:

- STANDARD:
 - E-coated and Powder coated
- OPTIONAL:
 - Hot dipped galvanised and powder coated
 - Hot dipped galvanised only (no coating)

GROUND FIXING OPTIONS

- Bolt Down (BD): M10 x 75mm Bolt Screw Anchor GAL
- In Ground (IG): J Bolt Kit GAL

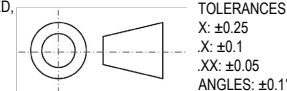
				 <p>© FURPHY FOUNDRY PTY LTD THIS DOCUMENT IS AND SHALL REMAIN THE PROPERTY OF FURPHY FOUNDRY. UNAUTHORISED USE OF THIS DOCUMENT IN ANY FORM IS PROHIBITED.</p>	 <p>Furphy Foundry Pty Ltd PH: (03) 5831 2777 ABN 24 007 195 913 FAX: (03) 5831 2681 21 Drummond Rd. www.furphyfoundry.com.au Shepparton VIC 3630 sales@furphyfoundry.com.au</p>	CLIENT NAME FURPHY FOUNDRY		PROJECT No. FFSB003017	SIZE A3
						PROJECT FFSB003017 Civic TABLE STD BD		DATE 12/07/2024	DRAWN Ishwara Sanchez
				<p>UNLESS OTHERWISE SPECIFIED, DIMENSIONS ARE IN mm DO NOT SCALE BREAK ALL SHARP EDGES AND REMOVE BURRS</p>  <p>TOLERANCES X: ±0.25 X: ±0.1 XX: ±0.05 ANGLES: ±0.1°</p>		PART NUMBER ----	MATERIAL ----	DRAWING No. DWG-000004	SCALE 1:10
REV	DESCRIPTION	DATE	APPROVED				PAGE No. 1/2		