

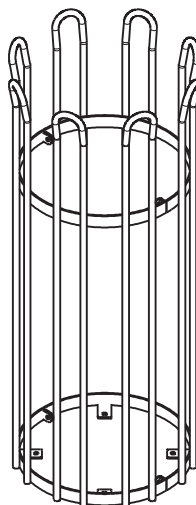

Quality
ISO 9001
SAI GLOBAL

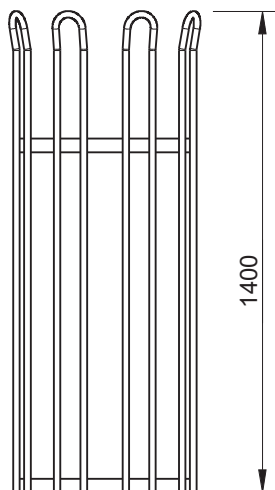
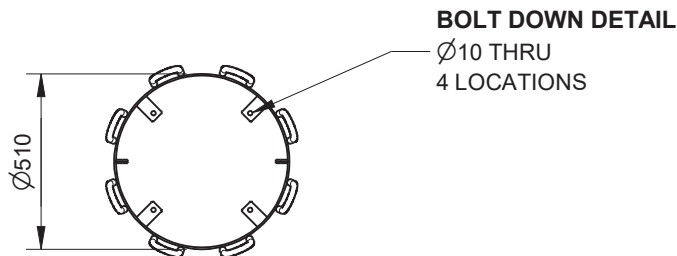

SPECIFICATION:

Material:
Frame & Slats: Mild Steel Construction

Dimensions:
All in mm unless otherwise stated

Finish:
Steel - Galvanised and optional Powder Coat

Ground Fixings:
Bolt Down



CONFIDENTIAL

REVISION #	DESCRIPTION	BY	DATE	DRAWN	DRAWN DATE	CHECKED	CHECKED DATE	SCALE	A4
								N/A	
1	ORIGINAL DRAWING	DN	21.2.11	R.CRIGTON	17.12.13				
2	FULL PRODUCT REVIEW	RBC	17.12.13						
3									
4									
5									

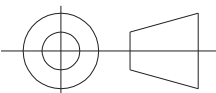

PIPELINE TREE GUARD - BOLT DOWN SPEC.

FFSB007007

REV.
2

SHEET
1 OF 2

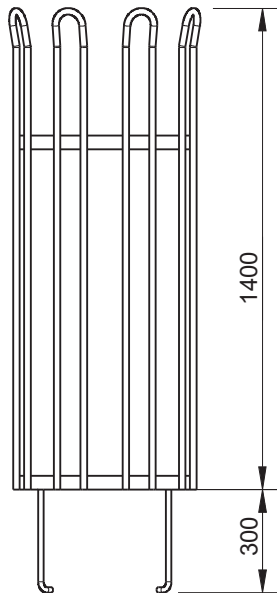
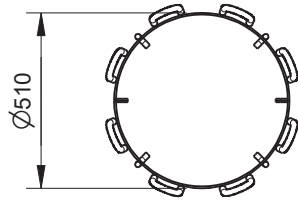

PORTION IN GROUND

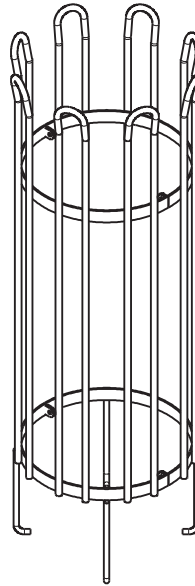

SPECIFICATION:

Material:
Frame & Slats: Mild Steel Construction

Dimensions:
All in mm unless otherwise stated

Finish:
Steel - Galvanised and optional Powder Coat

Ground Fixings:
In ground



Quality
ISO 9001
SAI GLOBAL



CONFIDENTIAL

REVISION #	DESCRIPTION	BY	DATE	DRAWN	DRAWN DATE	CHECKED	CHECKED DATE	SCALE	A4
2	FULL PRODUCT REVIEW	RBC	17.12.13						
3									
4									
5									

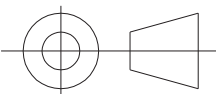

PIPELINE TREE GUARD - IN GROUND SPEC.

FFSB007008

REV.
2

SHEET
1 OF 2

IMPACT FURNITURE RANGE

FFSB014008 PLANTER BOX - 1800 RECTANGLE

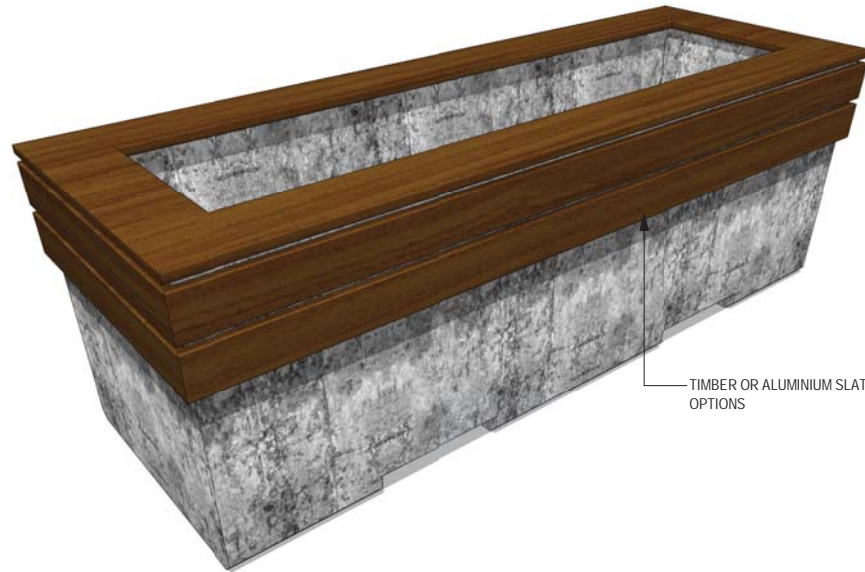

1 ELEVATIONAL PERSPECTIVE
@ A3

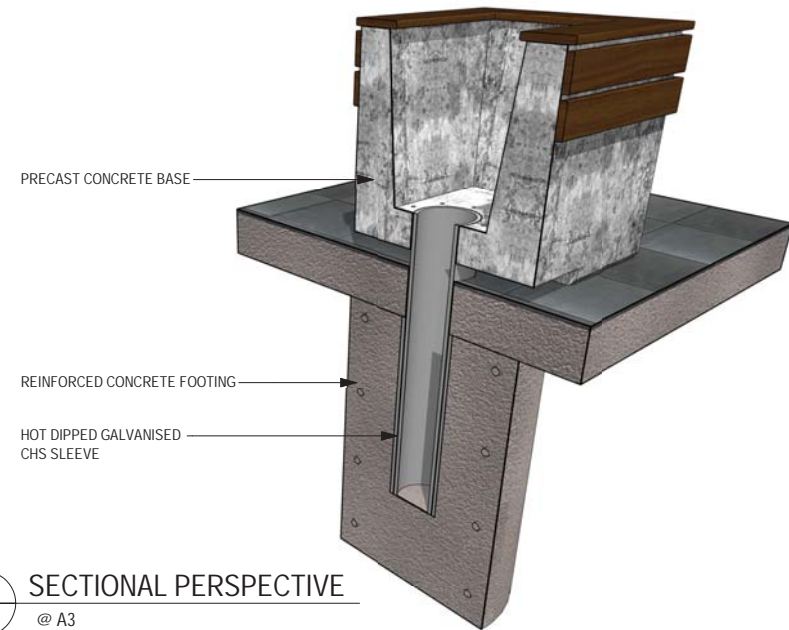

2 SECTIONAL PERSPECTIVE
@ A3

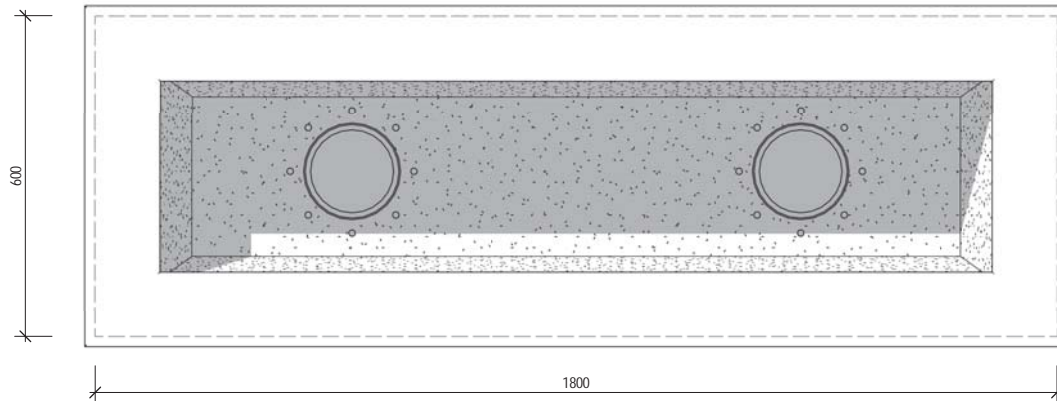

3 PLAN
001 1: 10 @ A3

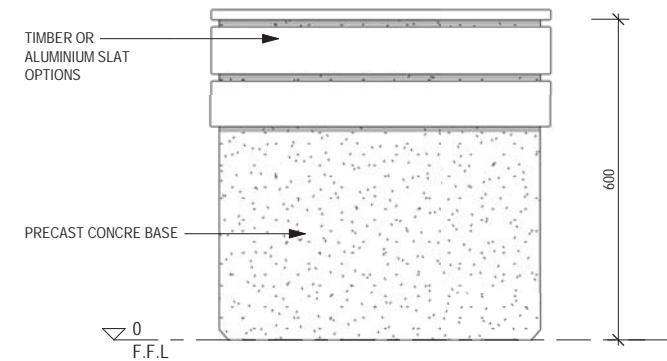

4 END ELEVATION
1: 10 @ A3

APPROX WEIGHT PER UNIT: 950kg





Quality
ISO 9001
SAI GLOBAL

SPECIFICATION:

Material:
Frame & Slats: Mild Steel Construction

Dimensions:
All in mm unless otherwise stated

Finish:
Steel - Galvanised and optional Powder Coat

Ground Fixings:
Bolt Down



CONFIDENTIAL

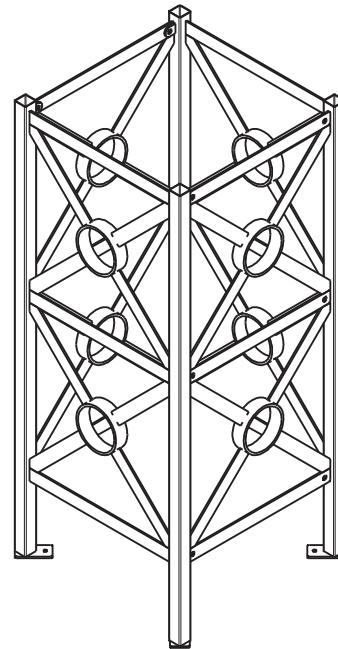
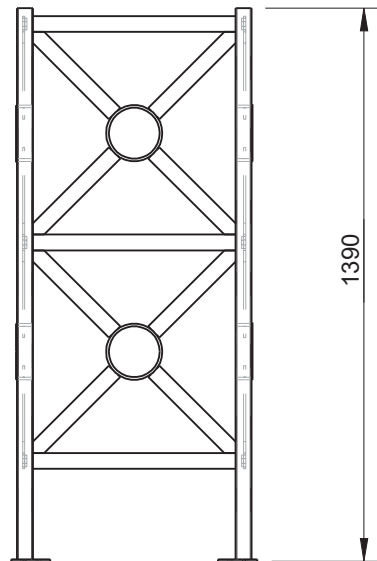
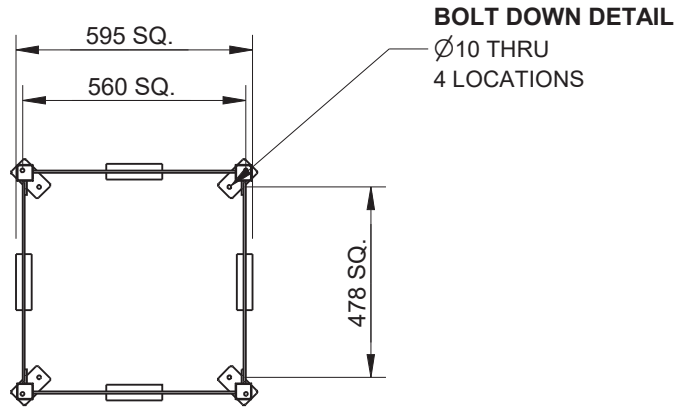

REVISION #	DESCRIPTION	BY	DATE	DRAWN	DRAWN DATE	CHECKED	CHECKED DATE	SCALE	A4
2						SQUARELINE TREE GUARD - BOLT DOWN SPEC.			
3									
4						FFSB007005	REV. 1	SHEET 1 OF 2	
5									

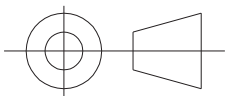

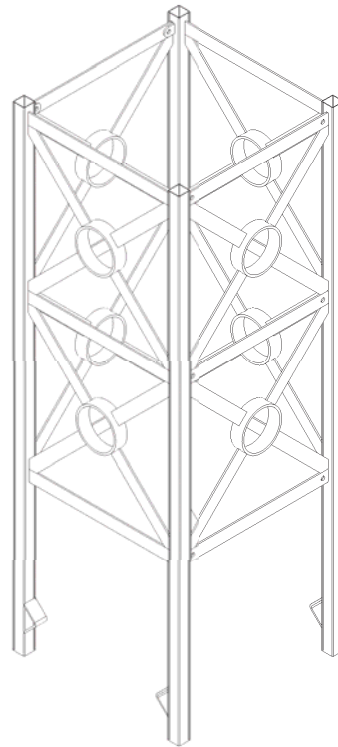
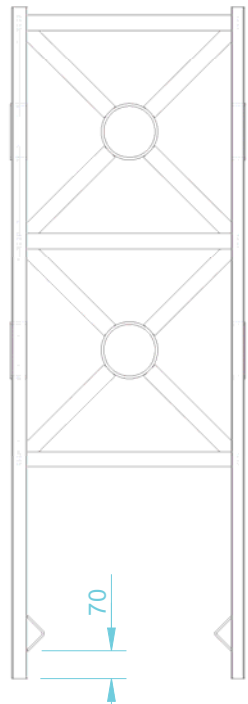
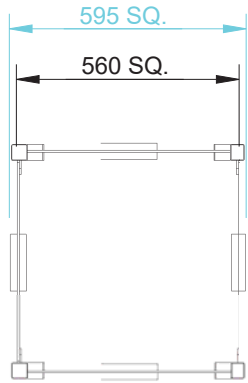

SPECIFICATION:

Material:
Frame & Slats: Mild Steel Construction

Dimensions:
All in mm unless otherwise stated

Finish:
Steel - Galvanised and optional Powder Coat

Ground Fixings:
In ground



Quality
ISO 9001
SAI GLOBAL



CONFIDENTIAL

REVISION #	DESCRIPTION	BY	DATE	DRAWN	DRAWN DATE	CHECKED	CHECKED DATE	SCALE	A4
2	FULL PRODUCT REVIEW	RBC	17.12.13						
3									
4									
5									

SQUARELINE TREE GUARD - IN GROUND SPEC.

FFSB007006

REV. 2

SHEET 1 OF 2

IMPACT FURNITURE RANGE

FFB014006 PLANTER BOX - SQUARE 1350

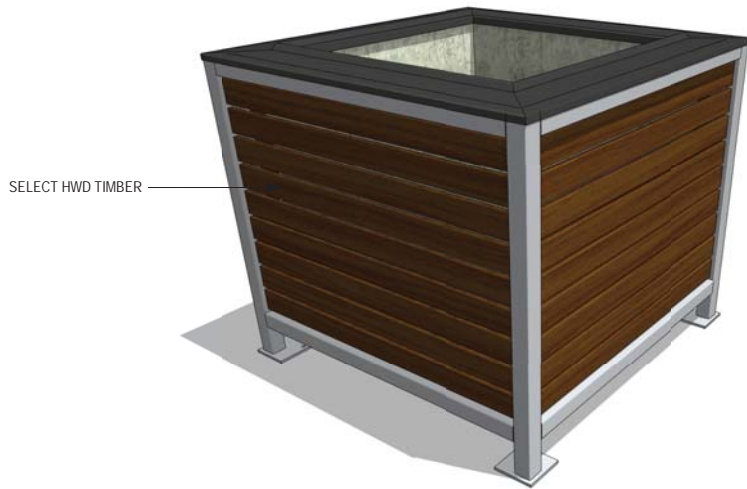

4 ELEVATIONAL PERSPECTIVE
@ A3



1 SECTIONAL PERSPECTIVE
@ A3

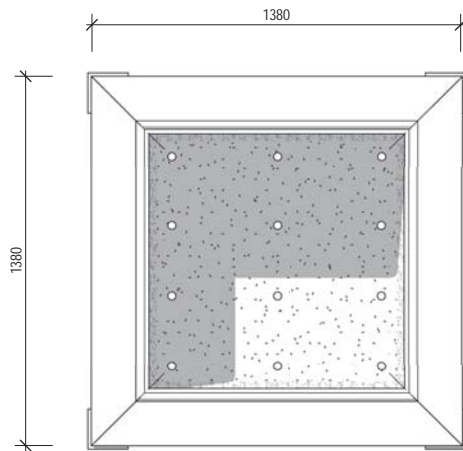

3 PLAN
001 1:20 @ A3

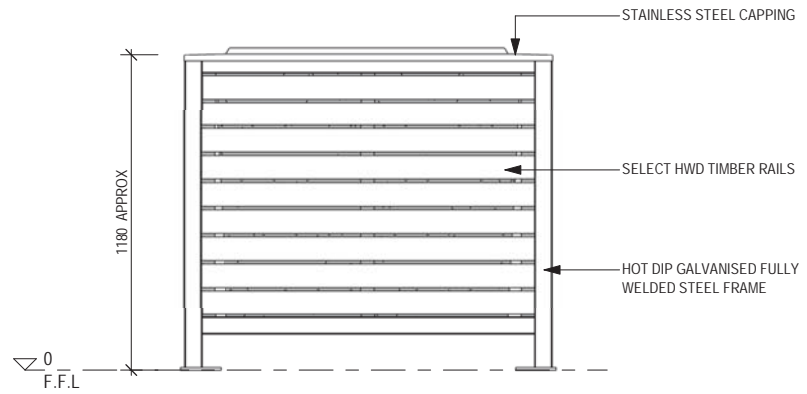

2 END ELEVATION
1:20 @ A3

APPROX WEIGHT PER UNIT: 500kg



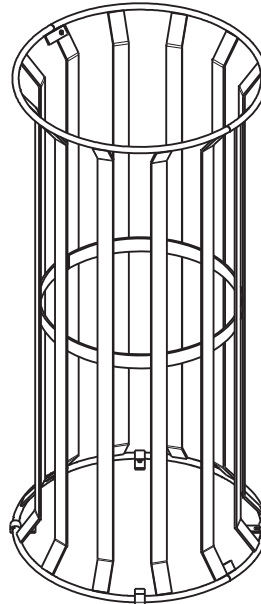
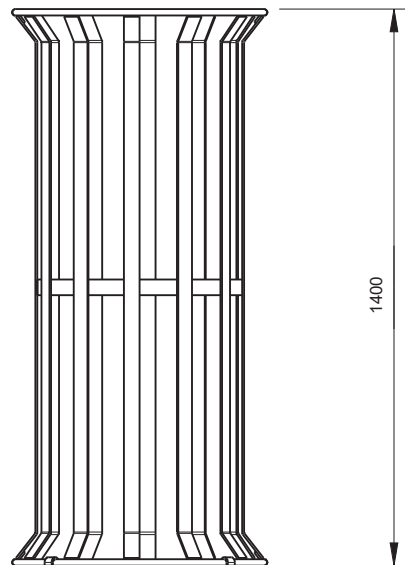
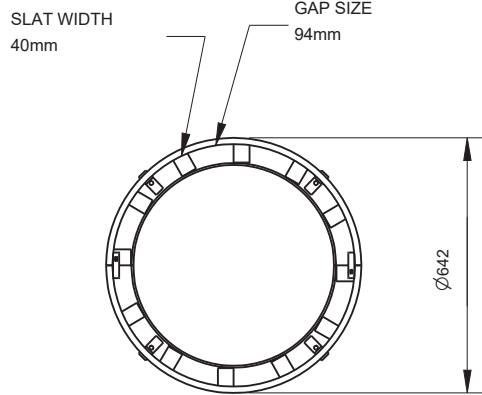

SPECIFICATION:

Material:
Frame & Slats: Mild Steel Construction

Dimensions:
All in mm unless otherwise stated

Finish:
Steel - Galvanised and optional Powder Coat

Ground Fixings: Bolt
Down



Quality
ISO 9001
SAI GLOBAL



CONFIDENTIAL

#	DESCRIPTION ORIGINAL	BY	DATE	DRAWN	DRAWN DATE	CHECKED	CHECKED DATE	SCALE	A4
1	DRAWING FULL PRODUCT REVIEW	DN	25.2.11	R.CRUGHTON	16.12.13			N/A	
2		RBC	16.12.13						
3									
4									
5									

REVISION

STEEL SLATTED TREE GUARD - BOLT DOWN SPEC.

FFSB007003

REV. 2	SHEET 1 OF 3
-----------	-----------------

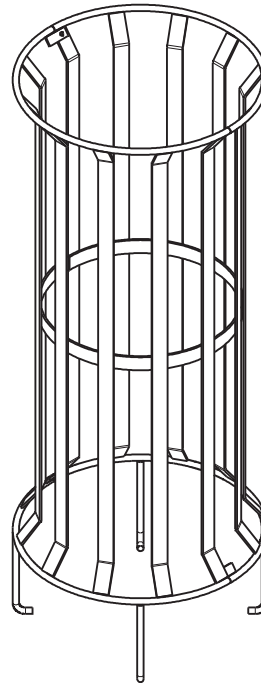
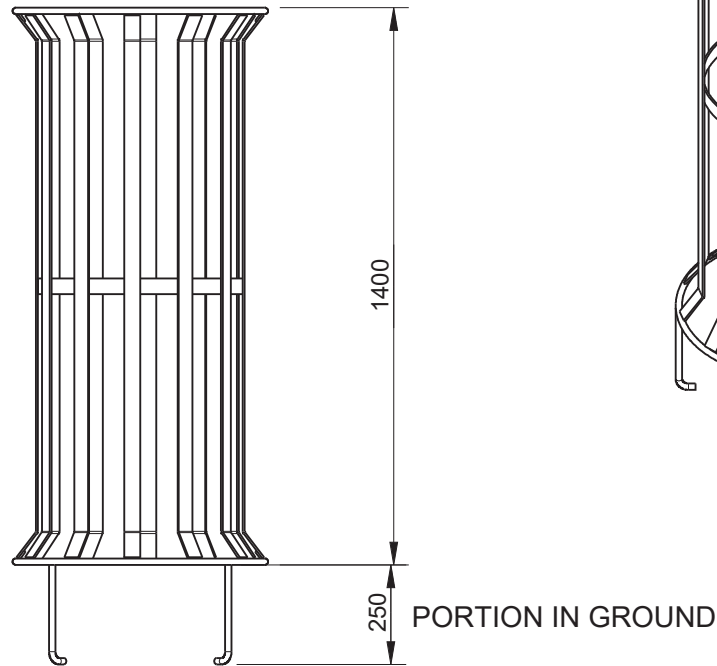
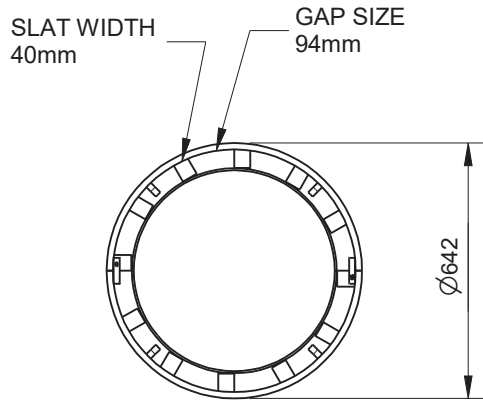

SPECIFICATION:

Material:
Frame & Slats: Mild Steel Construction

Dimensions:
All in mm unless otherwise stated

Finish:
Steel - Galvanised and optional Powder Coat

Ground Fixings:
In ground



Quality
ISO 9001
SAI GLOBAL



CONFIDENTIAL

REVISION #	DESCRIPTION	BY	DATE	DRAWN	DRAWN DATE	CHECKED	CHECKED DATE	SCALE	A4
2	FULL PRODUCT REVIEW	RBC	17.12.13						
3									
4									
5									

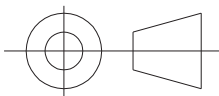

STEEL SLATTED TREE GUARD - IN GROUND SPEC.

FFSB007004

REV. 2

SHEET 1 OF 3



Quality
ISO 9001
SAI GLOBAL

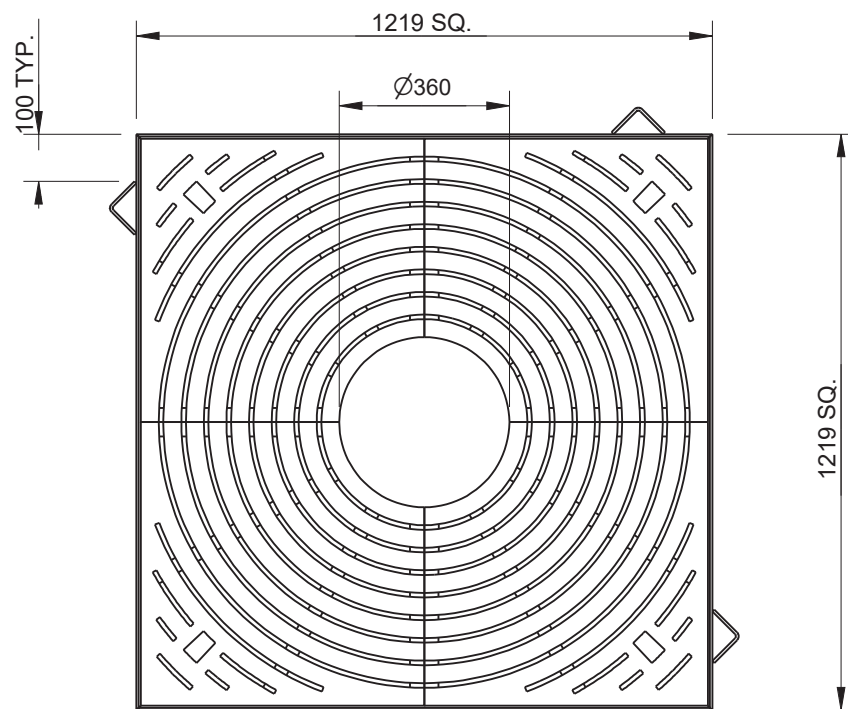

CONCRETE FIXING

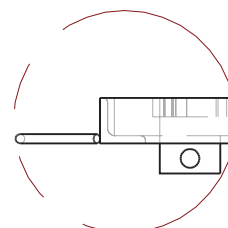
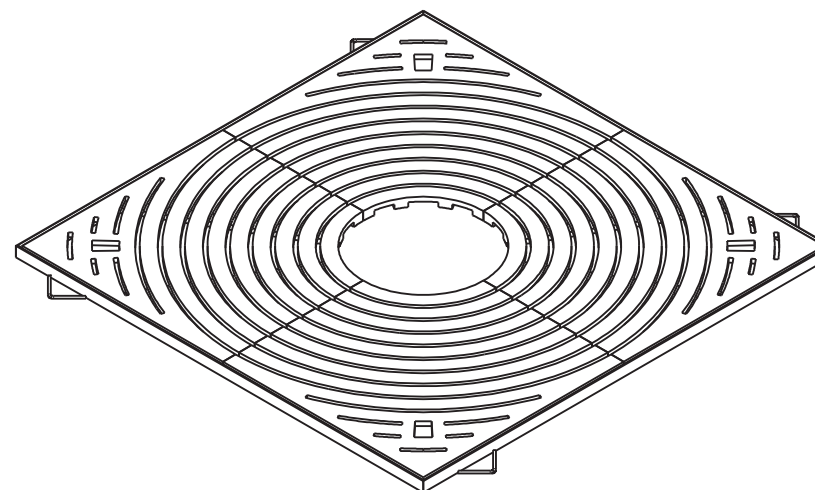

Detail A
LUG PLACEMENT
HIDDEN LINES SHOWN

SPECIFICATION:

MATERIALS:

Grate - Recycled Aluminum
Frame - Mild Steel

DIMENSIONS:

All in mm unless otherwise stated

FINISH:

Frame - Galvanised & Optional Powder Coat
Grate - Mill or Optional Powder Coat



copyright

CONFIDENTIAL

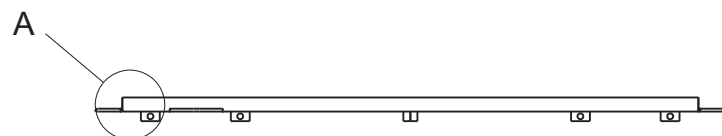

REVISION #	DESCRIPTION	BY	DATE	DRAWN	DRAWN DATE	CHECKED	CHECKED DATE	SCALE	A4
2	FULL PRODUCT REVIEW	RBC	9.12.13						
3									
4									
5									

TREE GRATE 1219x1219
SPEC.

FFSA006003

REV.
2

SHEET
1 OF 2



Quality
ISO 9001
SAI GLOBAL

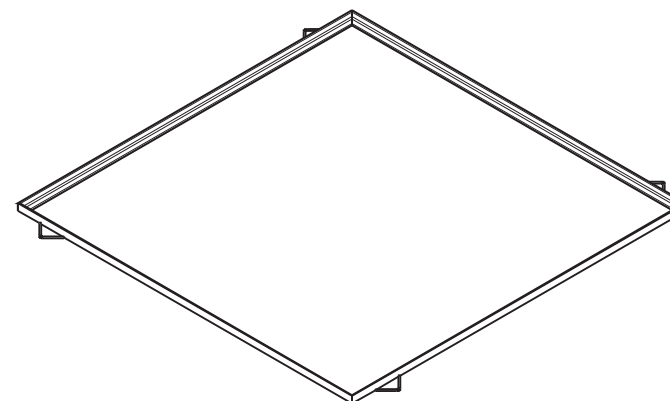
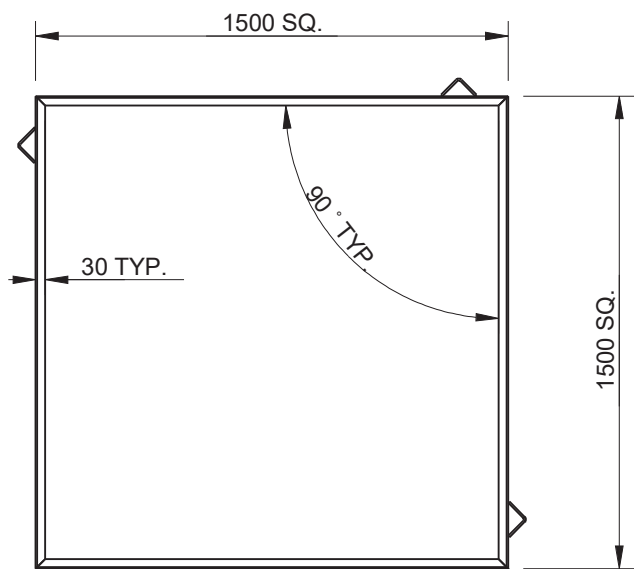

CONCRETE FIXING

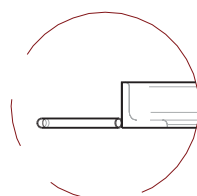

Detail A
LUG PLACEMENT
HIDDEN LINES SHOWN



SPECIFICATION:

MATERIALS:

Grate - 100% Recycled Aluminum
Frame - Mild Steel

DIMENSIONS:

All in mm unless otherwise stated

FINISH:

Frame - Galvanised & Optional Powder Coat
Grate - Mill or Optional Powder Coat



CONFIDENTIAL

REVISION #	DESCRIPTION	BY	DATE	DRAWN	DRAWN DATE	CHECKED	CHECKED DATE	SCALE	A4
2	FULL PRODUCT REVIEW	RBC	10.12.13						
3									
4									
5									

TREE GRATE 1500x1500
SPEC.

FFSA006004

REV.
2

SHEET
1 OF 2