



Quality  
ISO 9001  
SAI GLOBAL

# SPECIFICATION:

**Material:**  
Top - Recycled aluminium  
Column & base - Mild steel

**Dimensions:**  
All in mm unless otherwise stated

**Finish:**  
Steel - Galvanised mild steel & optional powder coat

**Ground Fixings:**  
Bolt down

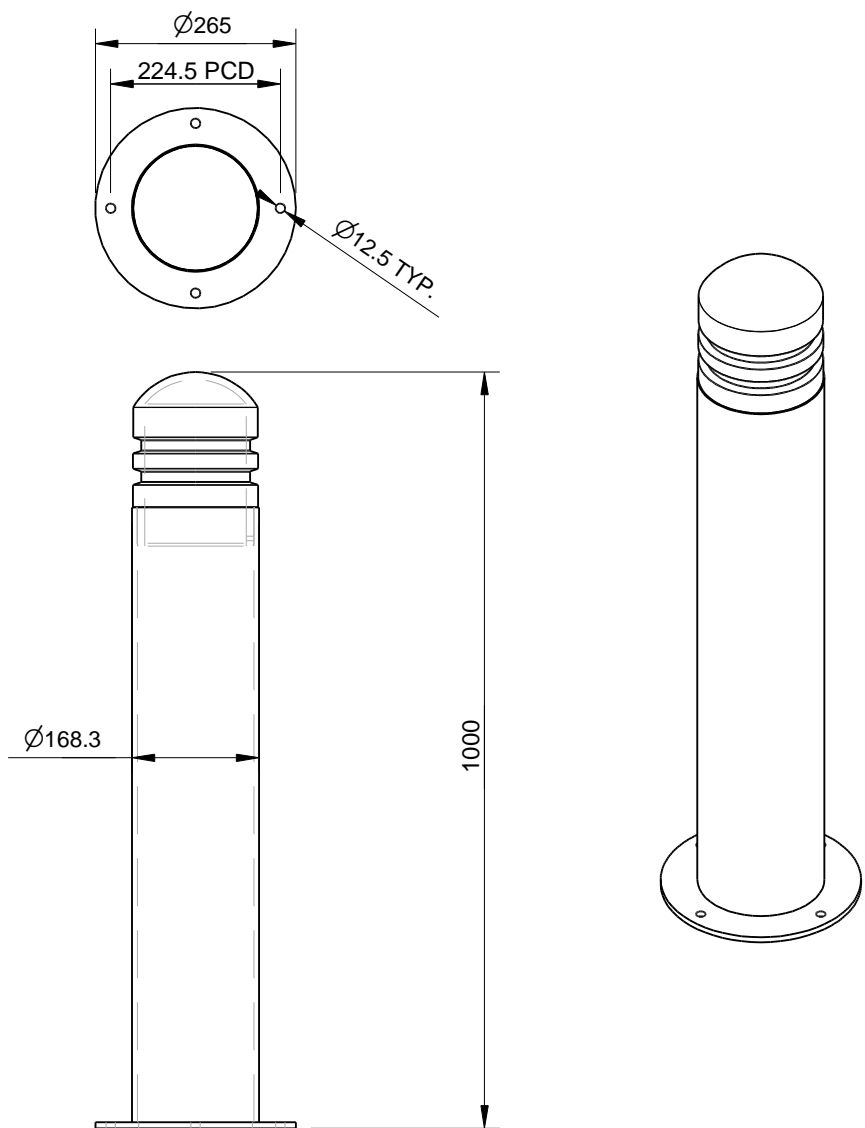

copyright

CONFIDENTIAL

REVISION #	DESCRIPTION	BY	DATE	DRAWN	DRAWN DATE	CHECKED	CHECKED DATE	SCALE	A4
								N/A	
1	ORIGINAL DRAWING	SJ	6.9.10	R.CRIGTON	18.12.13				
2	FULL PRODUCT REVIEW	RBC	18.12.13						
3									
4									
5									
						B11 BOLLARD - BOLT DOWN SPEC.			
							FFSB008004	REV. 2	SHEET 1 OF 2





Quality  
ISO 9001  
SAI GLOBAL

## SPECIFICATION:

### Material:

Top - Recycled aluminium  
Column & base - Mild steel

### Dimensions:

All in mm unless otherwise stated

### Finish:

Steel - Galvanised mild steel & optional powder coat

### Ground Fixings:

Removable.  
Attaches to in ground component (FFSB008036)

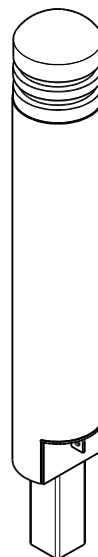
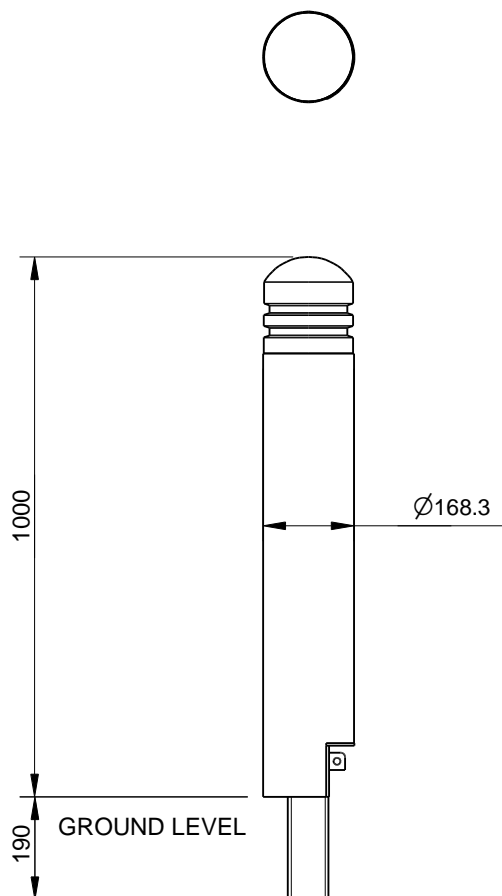

CONFIDENTIAL

REVISION #	DESCRIPTION	BY	DATE	DRAWN	DRAWN DATE	CHECKED	CHECKED DATE	SCALE	A4
1	ORIGINAL DRAWING	RBC	18.12.13	R.CRIGTON	18.12.13			N/A	
2									
3									
4									
5									

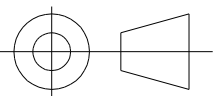

B11 BOLLARD - REMOVABLE  
SPEC.

FFSB008006

REV.  
1

SHEET  
1 OF 3



Quality  
ISO 9001  
SAI GLOBAL

## SPECIFICATION:

**Material:**  
Mild steel

**Dimensions:**  
All in mm unless otherwise stated

**Finish:**  
Steel - Galvanised mild steel & optional powder coat

**Ground Fixings:**  
Bolt down

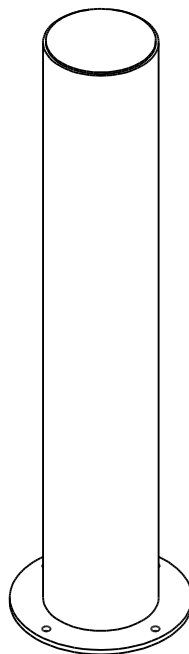
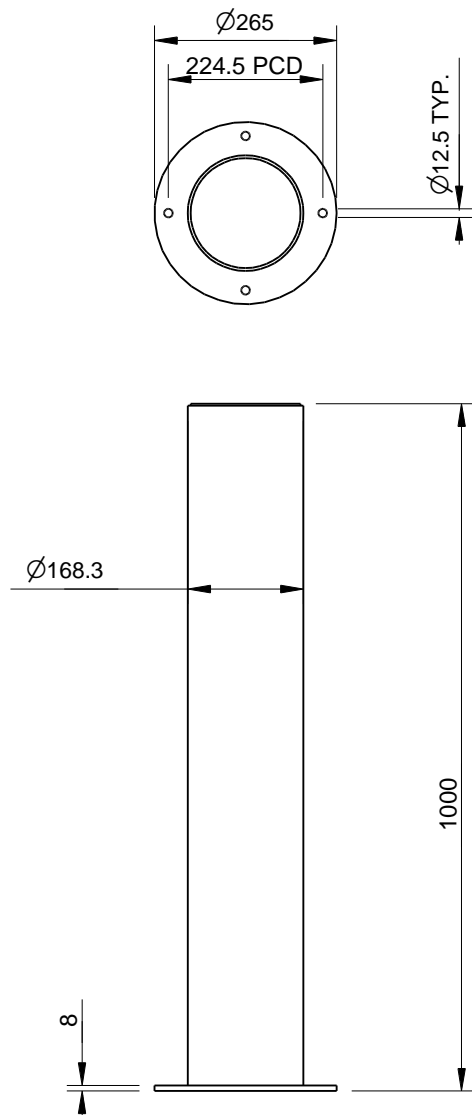

CONFIDENTIAL

REVISION #	DESCRIPTION	BY	DATE	DRAWN	DRAWN DATE	CHECKED	CHECKED DATE	SCALE		
								A4		
1	ORIGINAL DRAWING	SJ	25.5.10	R.CRIGTON	18.12.13			N/A		
2	FULL PRODUCT REVIEW	RBC	18.12.13					BARRIER BOLLARD - BOLT DOWN SPEC.		
3										
4										
5								FFSB008010	REV. 2	SHEET 1 OF 2

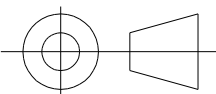

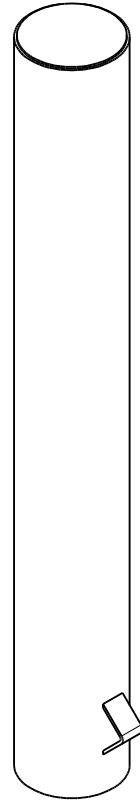
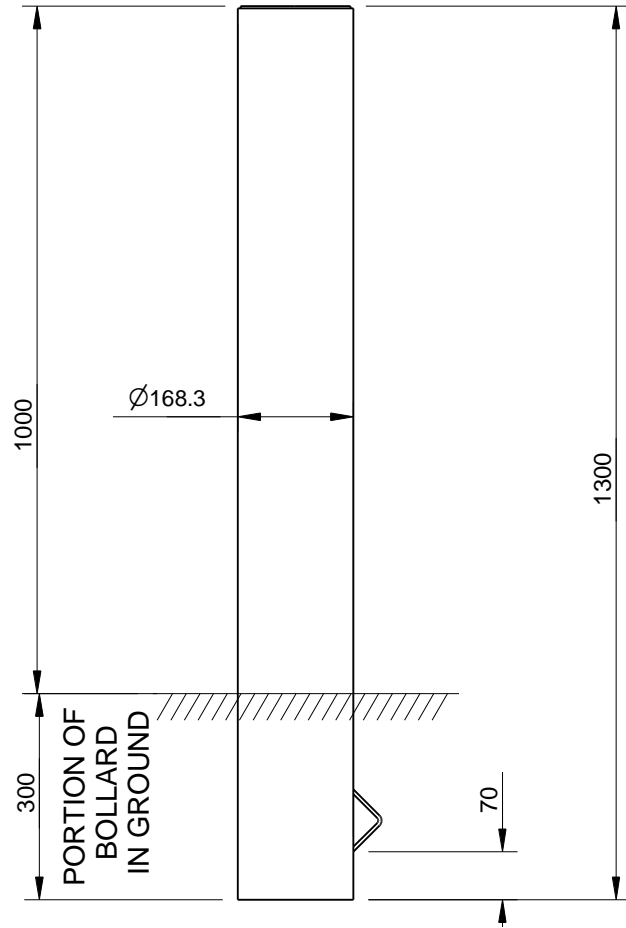
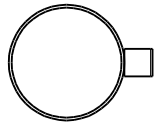

## SPECIFICATION:

**Material:**  
Mild steel

**Dimensions:**  
All in mm unless otherwise stated

**Finish:**  
Steel - Galvanised mild steel & optional powder coat

**Ground Fixings:**  
In ground



Quality  
ISO 9001  
SAI GLOBAL



CONFIDENTIAL

REVISION #	DESCRIPTION	BY	DATE	DRAWN	DRAWN DATE	CHECKED	CHECKED DATE	SCALE		
								A4		
1	ORIGINAL DRAWING	SJ	20.9.10	R.CRIGTON	18.12.13			N/A		
2	FULL PRODUCT REVIEW	RBC	18.12.13					BARRIER BOLLARD - IN GROUND SPEC.		
3										
4										
5								FFSB008011	REV. 2	SHEET 1 OF 2

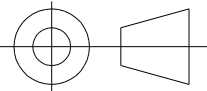

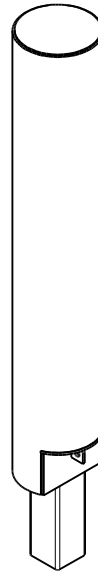
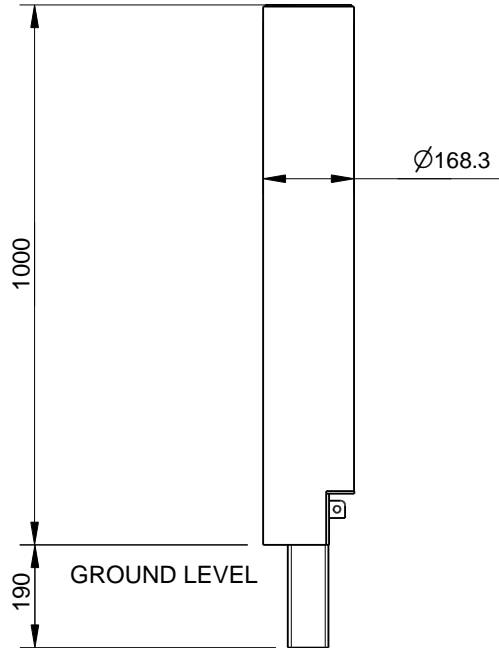
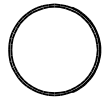

## SPECIFICATION:

**Material:**  
Mild steel

**Dimensions:**  
All in mm unless otherwise stated

**Finish:**  
Steel - Galvanised mild steel & optional powder coat

**Ground Fixings:**  
Removable.  
Attaches to in ground component (FFSB008036)



Quality  
ISO 9001  
SAI GLOBAL



CONFIDENTIAL

REVISION #	DESCRIPTION	BY	DATE	DRAWN	DRAWN DATE	CHECKED	CHECKED DATE	SCALE	
								A4	
1	ORIGINAL DRAWING	RBC	19.12.13	R.CRIGTON	19.12.13			N/A	
2									
3									
4									
5									
						BARRIER BOLLARD - REMOVABLE SPEC.			
						FFSB008012		REV. 1	SHEET 1 OF 3

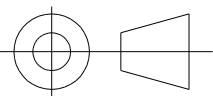



Quality  
ISO 9001  
SAI GLOBAL

## SPECIFICATION:

**Material:**  
Mild steel

**Dimensions:**  
All in mm unless otherwise stated

**Finish:**  
Steel - Galvanised mild steel & optional powder coat

**Ground Fixings:**  
Bolt down

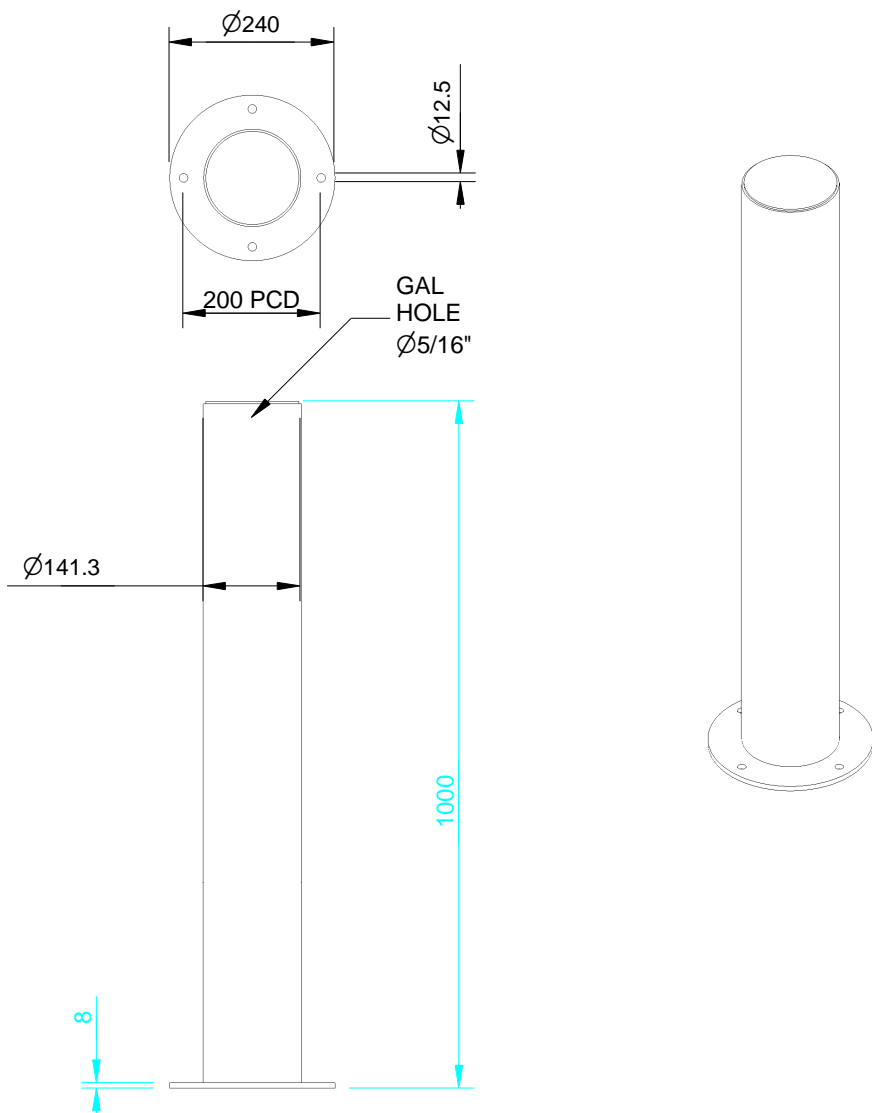

CONFIDENTIAL

REVISION #	DESCRIPTION	BY	DATE	DRAWN	DRAWN DATE	CHECKED	CHECKED DATE	SCALE	A4
								N/A	
1	ORIGINAL DRAWING	SJ	11.6.10	R.CRIGTON	19.12.13				
2	FULL PRODUCT REVIEW	RBC	19.12.13						
3									
4									
5									
						BARRIER BOLLARD (140mm) - BOLT DOWN SPEC.			
						FFSB008019		REV. 2	SHEET 1 OF 2

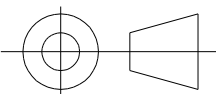



Quality  
ISO 9001  
SAI GLOBAL

## SPECIFICATION:

**Material:**  
Mild steel

**Dimensions:**  
All in mm unless otherwise stated

**Finish:**  
Steel - Galvanised mild steel & optional powder coat

**Ground Fixings:**  
In ground

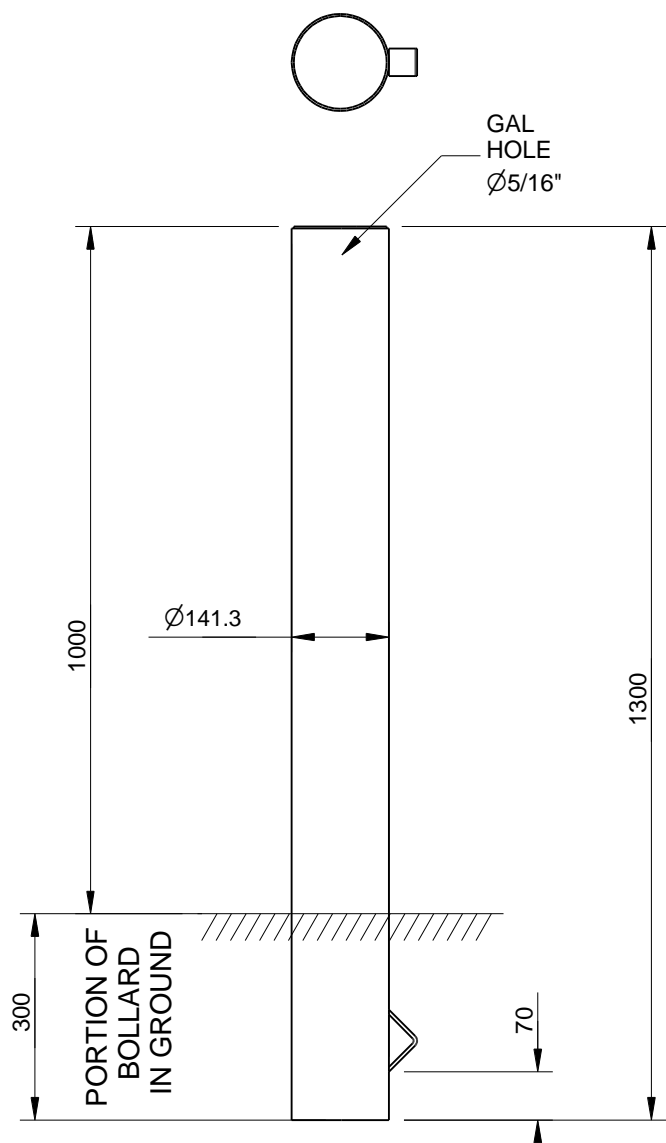

CONFIDENTIAL

REVISION	#	DESCRIPTION	BY	DATE	DRAWN	DRAWN DATE	CHECKED	CHECKED DATE	SCALE	A4
	1	ORIGINAL DRAWING	SJ	20.9.10	R.CRIGTON	19.12.13			N/A	
2	FULL PRODUCT REVIEW	RBC	19.12.13							
3										
4										
5										
							BARRIER BOLLARD (140mm) - IN GROUND SPEC.			
							FFSB008020	REV. 2	SHEET 1 OF 2	



# PROCEDURE

1. Cut pipe to length - 997mm
2. Clean and square top end of pipe.
3. Place cap on top of pipe having an even gap around the top edge. Tack in place and fully weld dress flush.
4. Using an angle grinder with cutting disk, remove section of pipe 100mm longitudinally, and 33mm from pipe centre. See detail. This corresponds to a 153mm distance around the pipe (if 141.3 O.D.).
5. Tack in arc plate. Ensure square and check dimensions. Fully weld and dress flush with pipe.
6. Tack together SHS, 120x5x95 plate, back gusset, and cleat. Refer to detail A. Ensure square and fully weld.
7. Tack together the lower assembly to the pipe assembly. Ensure the SHS is colinear with the pipe and is square, this is essential. Check and fully weld, dress flush with outside of pipe.
8. Drill 5/16 holes in top as per Spec for galvanising
9. After galvanising and painting, install a 30mm wide reflective tape 150mm down from top.
10. Final inspection.

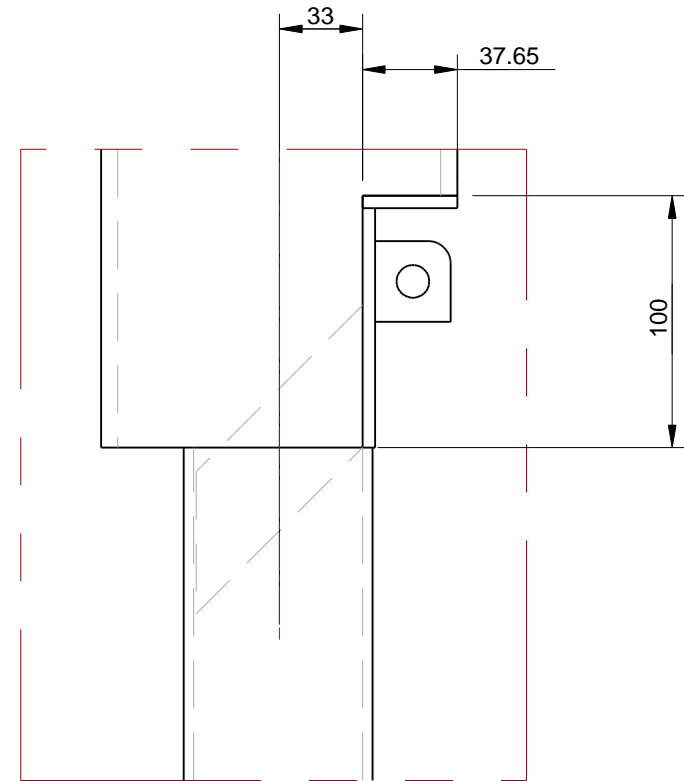
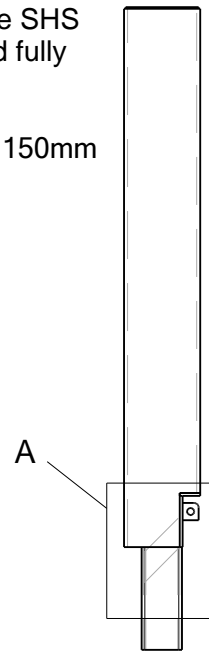

Detail A



Quality  
ISO 9001  
SAI GLOBAL



CONFIDENTIAL

REVISION	#	DESCRIPTION	BY	DATE	DRAWN	DRAWN DATE	CHECKED	CHECKED DATE	SCALE	A4
	1		ORIGINAL DRAWING	RBC	19.12.13	R.CRIGTON	19.12.13			
2										
3										
4										
5										

**FURPHY**  
FOUNDRY EST. 1864

**BARRIER BOLLARD (140mm) - REMOVABLE  
PROCEDURE & DETAIL**

**FFSB008021**

REV. 1

SHEET 3 OF 3



Quality  
ISO 9001  
SAI GLOBAL

## SPECIFICATION:

**MATERIALS:**  
100% Recycled Aluminum

**DIMENSIONS:**  
All in mm unless otherwise stated

**FINISH:**  
Mill or Optional Powder Coat

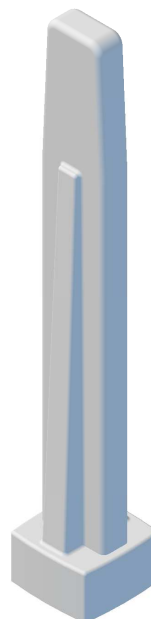
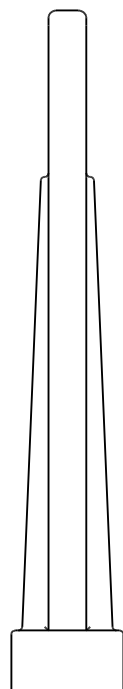
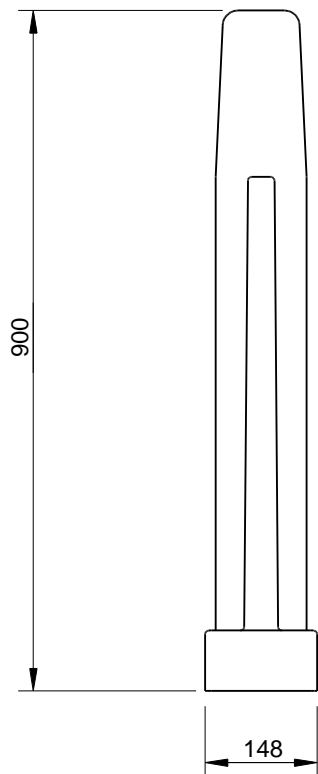
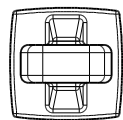

CONFIDENTIAL

REVISION	#	DESCRIPTION	BY	DATE	DRAWN	DRAWN DATE	CHECKED	CHECKED DATE	SCALE	A4
	1		ORIGINAL DRAWING			R.CRIGTON	26.3.14			
2							CORSO BOLLARD SPEC.			
3										FFSA008007
4										
5										

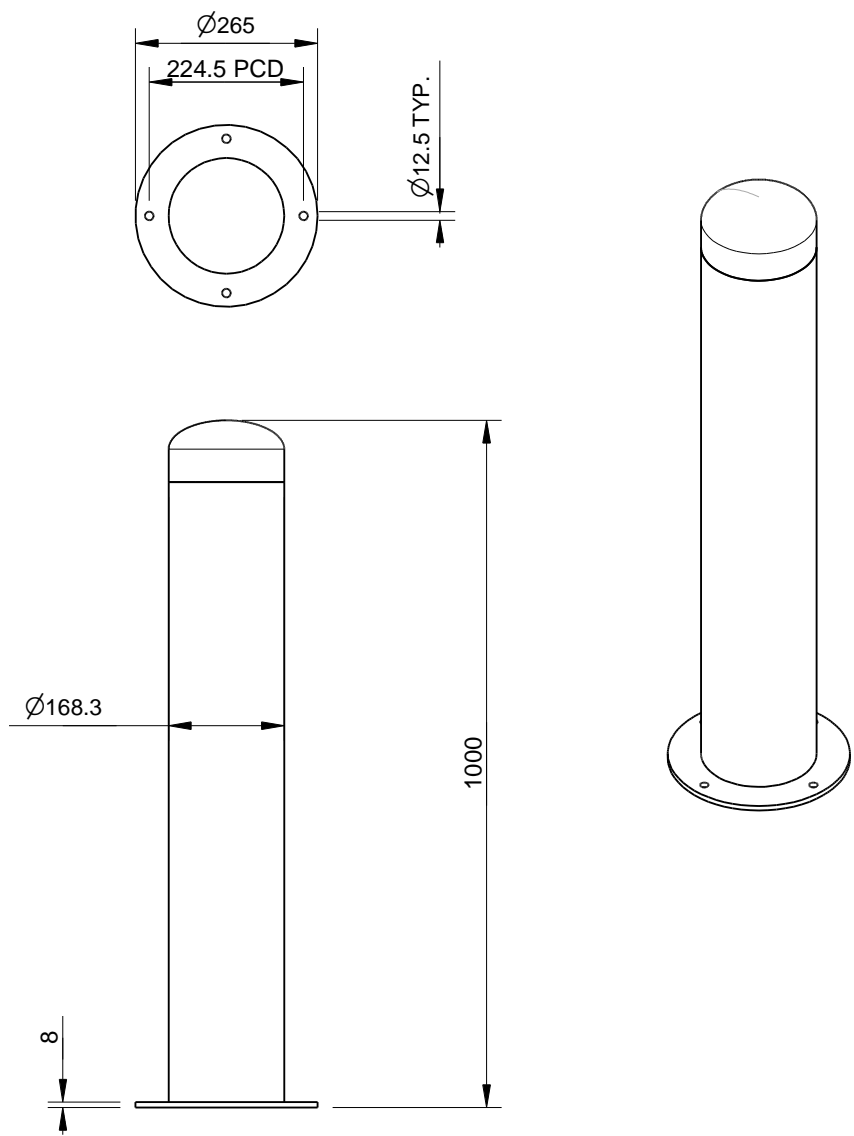

# SPECIFICATION:

**Material:**  
Mild steel

**Dimensions:**  
All in mm unless otherwise stated

**Finish:**  
Steel - Galvanised mild steel & optional powder coat

**Ground Fixings:**  
Bolt down



Quality  
ISO 9001  
SAI GLOBAL



CONFIDENTIAL

REVISION	#	DESCRIPTION	BY	DATE	DRAWN	DRAWN DATE	CHECKED	CHECKED DATE	SCALE	A4
	1	ORIGINAL DRAWING	SJ	1.1.11	R.CRIGTON	19.12.13			N/A	
2	FULL PRODUCT REVIEW	RBC	19.12.13							
3										
4										
5										

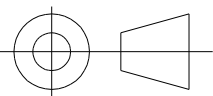

DOMETOP BOLLARD - BOLT DOWN SPEC.

FFSB008013

REV. 2

SHEET 1 OF 2



Quality  
ISO 9001



## SPECIFICATION:

**Material:**  
Mild steel

**Dimensions:**  
All in mm unless otherwise stated

**Finish:**  
Steel - Galvanised mild steel & optional powder coat

**Ground Fixings:**  
In ground

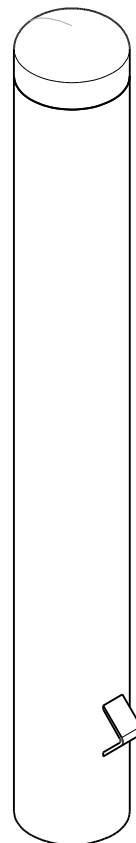
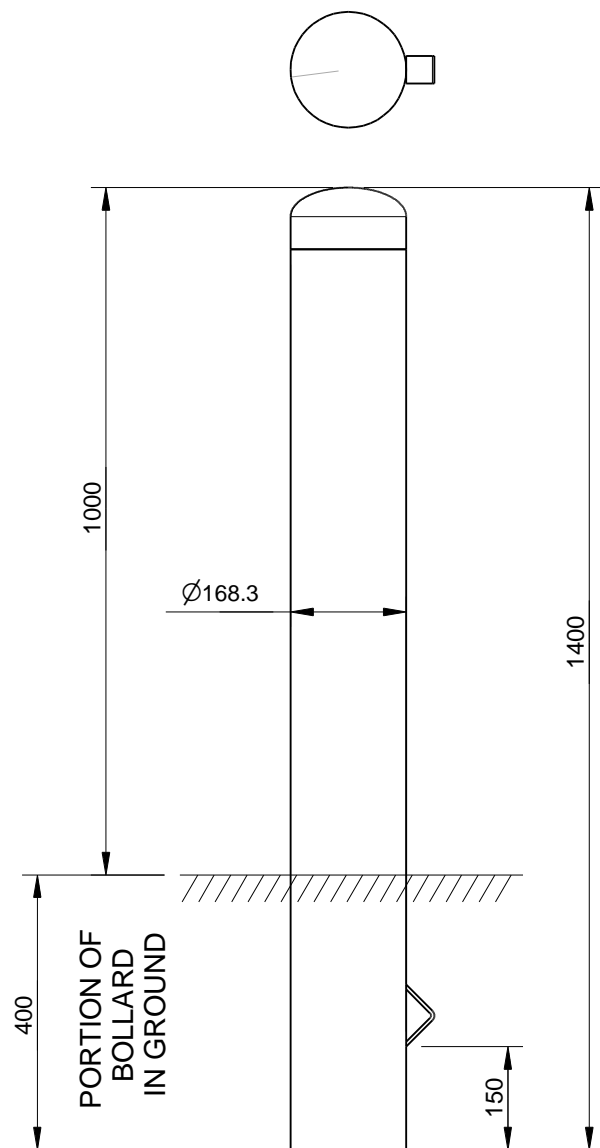

CONFIDENTIAL

REVISION #	DESCRIPTION	BY	DATE	DRAWN	DRAWN DATE	CHECKED	CHECKED DATE	SCALE		A4
								N/A		
1	ORIGINAL DRAWING	SJ	2.1.11	R.CRIGTON	19.12.13					
2	FULL PRODUCT REVIEW	RBC	19.12.13							
3										
4										
5										
						DOMETOP BOLLARD - IN GROUND SPEC.				
										FFSB008014



Quality  
ISO 9001  
SAI GLOBAL

## SPECIFICATION:

**Material:**  
Mild steel

**Dimensions:**  
All in mm unless otherwise stated

**Finish:**  
Steel - Galvanised mild steel & optional powder coat

**Ground Fixings:**  
Removable.  
Attaches to in ground component (FFSB008036)

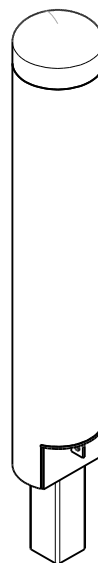
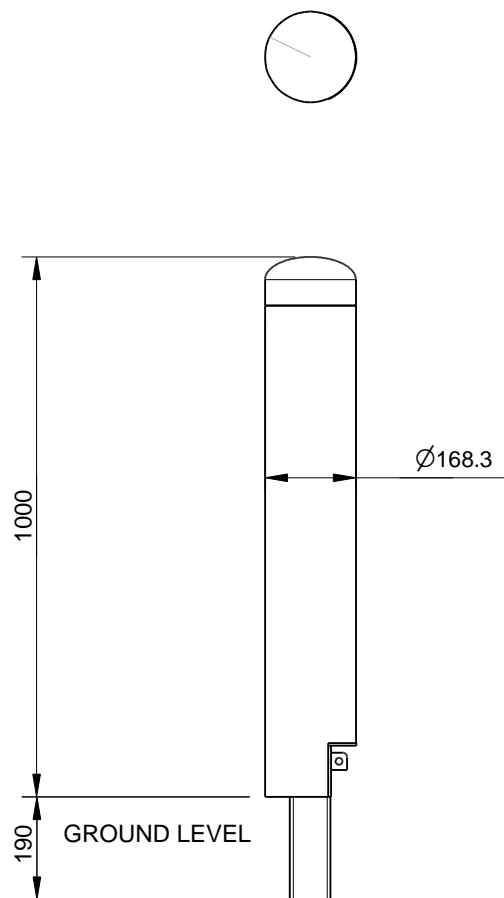

CONFIDENTIAL

REVISION	#	DESCRIPTION	BY	DATE	DRAWN	DRAWN DATE	CHECKED	CHECKED DATE	SCALE	A4
	1	1	ORIGINAL DRAWING	RBC	19.12.13	R.CRIGTON	19.12.13			
2	2						DOMETOP BOLLARD - REMOVABLE SPEC.			
3	3									
4	4						FFSB008015			
5	5									

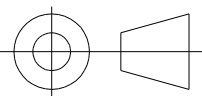

REV. 1 SHEET 1 OF 3



Quality  
ISO 9001  
SAI GLOBAL

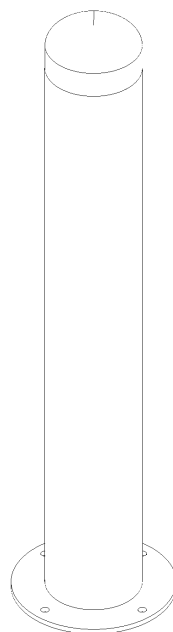
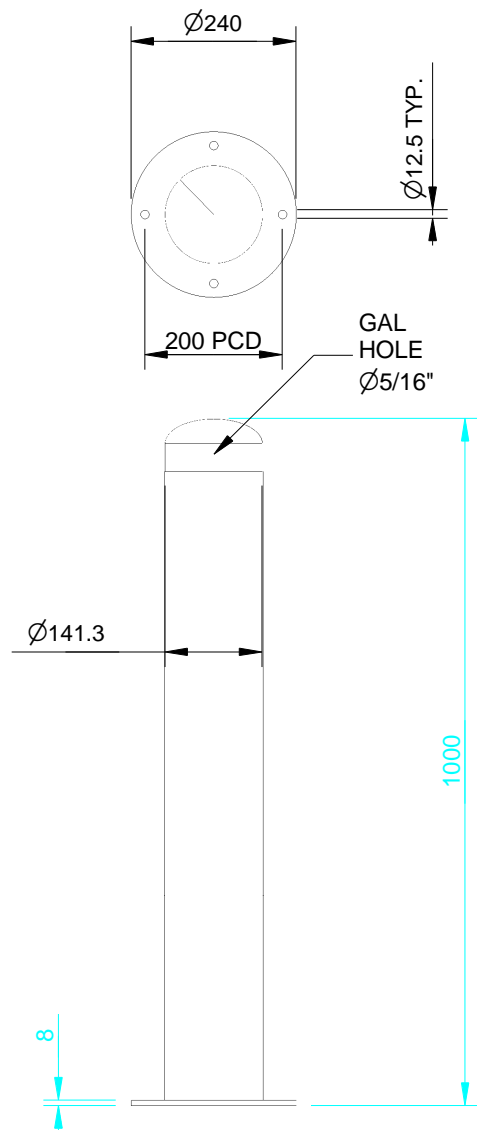

## SPECIFICATION:

**Material:**  
Mild steel

**Dimensions:**  
All in mm unless otherwise stated

**Finish:**  
Steel - Galvanised mild steel & optional powder coat

**Ground Fixings:**  
Bolt down



CONFIDENTIAL

REVISION #	DESCRIPTION	BY	DATE	DRAWN	DRAWN DATE	CHECKED	CHECKED DATE	SCALE
								A4
1	ORIGINAL DRAWING	SJ	2.1.11	R.CRIGTON	19.12.13			N/A
2	FULL PRODUCT REVIEW	RBC	19.12.13					
3								
4								
5								
						DOMETOP BOLLARD (140mm) - BOLT DOWN SPEC.		
						FFSB008016	REV. 2	SHEET 1 OF 2

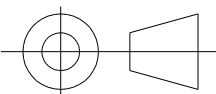



Quality  
ISO 9001  
SAI GLOBAL

## SPECIFICATION:

**Material:**  
Mild steel

**Dimensions:**  
All in mm unless otherwise stated

**Finish:**  
Steel - Galvanised mild steel & optional powder coat

**Ground Fixings:**  
In ground

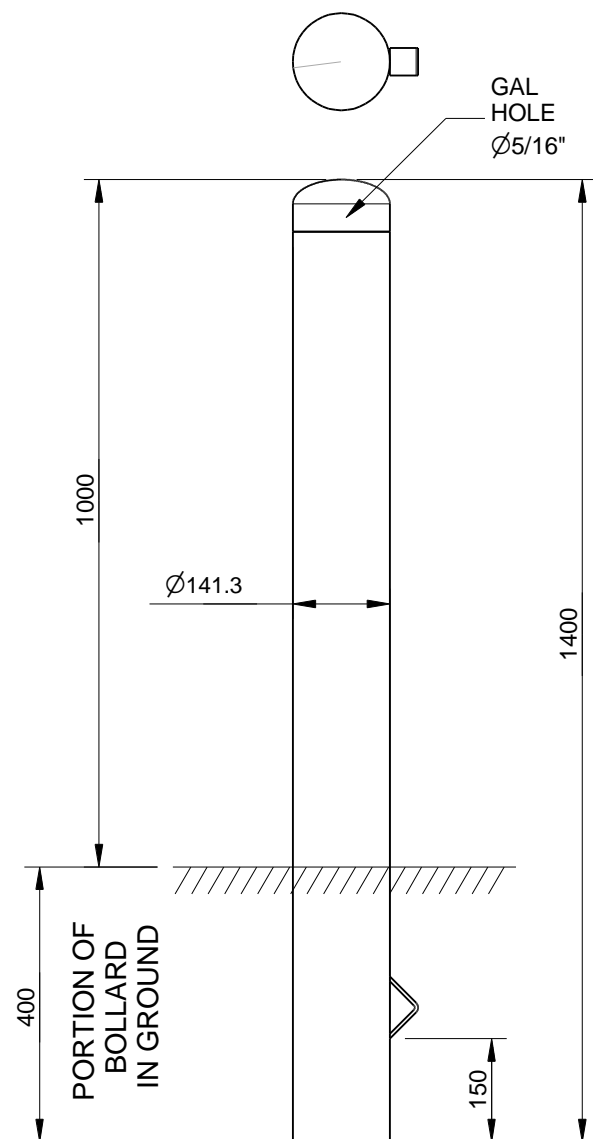

CONFIDENTIAL

REVISION #	DESCRIPTION	BY	DATE	DRAWN	DRAWN DATE	CHECKED	CHECKED DATE	SCALE		
								A4		
1	ORIGINAL DRAWING	SJ	2.1.11	R.CRIGTON	19.12.13			N/A		
2	FULL PRODUCT REVIEW	RBC	19.12.13					DOMETOP BOLLARD (140mm) - IN GROUND SPEC.		
3										
4										
5								FFSB008017	REV. 2	SHEET 1 OF 2

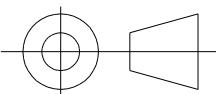

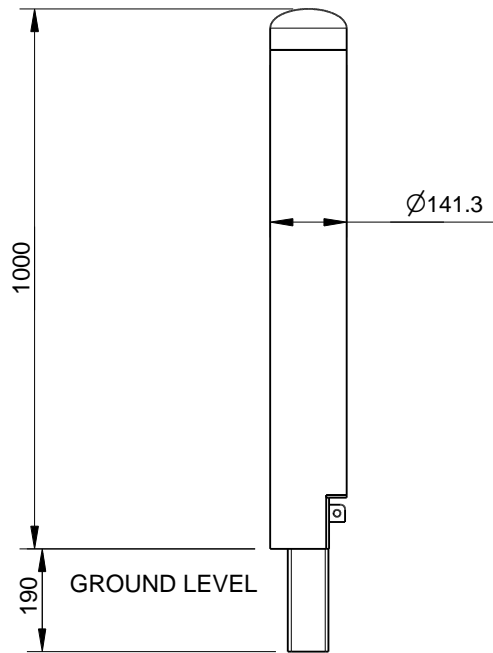

## SPECIFICATION:

**Material:**  
Mild steel

**Dimensions:**  
All in mm unless otherwise stated

**Finish:**  
Steel - Galvanised mild steel & optional powder coat

**Ground Fixings:**  
Removable.  
Attaches to in ground component (FFSB008036)



Quality  
ISO 9001  
SAI GLOBAL



CONFIDENTIAL

REVISION #	DESCRIPTION	BY	DATE	DRAWN	DRAWN DATE	CHECKED	CHECKED DATE	SCALE	A4
								N/A	
1	ORIGINAL DRAWING	RBC	19.12.13	R.CRIGTON	19.12.13				
2									
3									
4									
5									

DOMETOP BOLLARD (140mm) - REMOVABLE SPEC.

FFSB008018

REV. 1

SHEET 1 OF 3



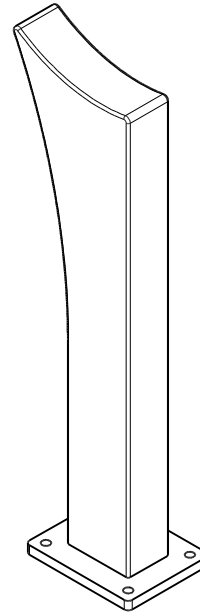
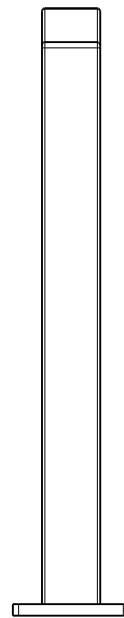
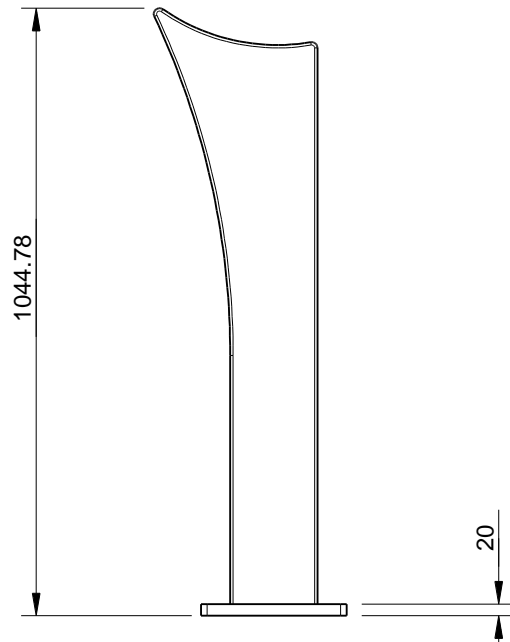
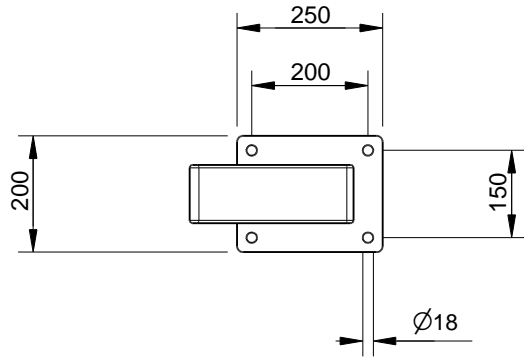

Quality  
ISO 9001  
SAI GLOBAL

## SPECIFICATION:

**Material:**  
Recycled aluminium

**Dimensions:**  
All in mm unless otherwise stated

**Finish:**  
Mill finish or Powder coat

**Ground Fixings:**  
Bolt down

© copyright

CONFIDENTIAL

REVISION	#	DESCRIPTION	BY	DATE	DRAWN	DRAWN DATE	CHECKED	CHECKED DATE	SCALE	A4
	1		ORIGINAL DRAWING	RBC	10.3.14	R.CRIGTON	10.3.14			
2										
3										
4										
5										

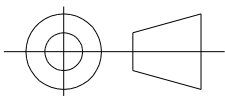

EDGEWATER BOLLARD  
SPEC.  
FFSA008004  
REV. 1  
SHEET 1 OF 2

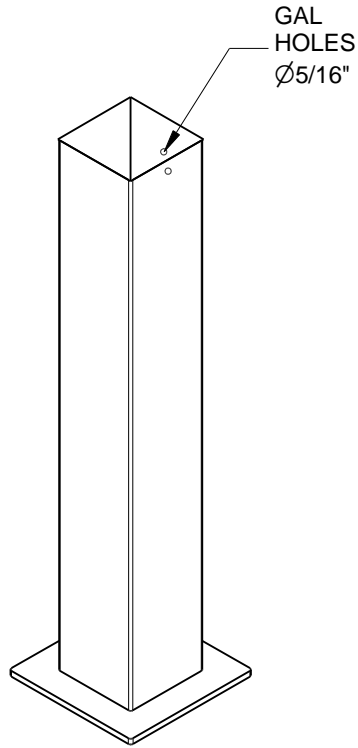
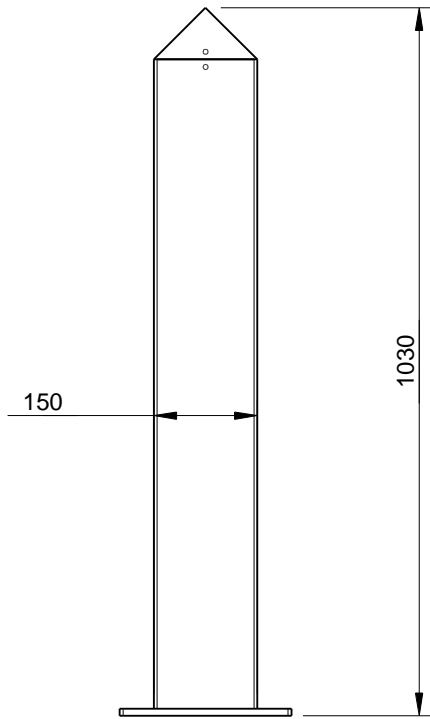
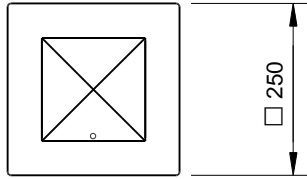

## SPECIFICATION:

**Material:**  
Mild steel

**Dimensions:**  
All in mm unless otherwise stated

**Finish:**  
Steel - Galvanised mild steel & optional powder coat

**Ground Fixings:**  
Bolt down



Quality  
ISO 9001  
SAI GLOBAL



CONFIDENTIAL

REVISION #	DESCRIPTION	BY	DATE	DRAWN	DRAWN DATE	CHECKED	CHECKED DATE	SCALE	A4
2	FULL PRODUCT REVIEW	RBC	19.12.13						
3									
4									
5									

GABLE TOP BOLLARD - BOLT DOWN SPEC.

FFSB008022

REV. 2

SHEET 1 OF 2



Quality  
ISO 9001  
SAI GLOBAL

## SPECIFICATION:

**Material:**  
Mild steel

**Dimensions:**  
All in mm unless otherwise stated

**Finish:**  
Steel - Galvanised mild steel & optional powder coat

**Ground Fixings:**  
In ground

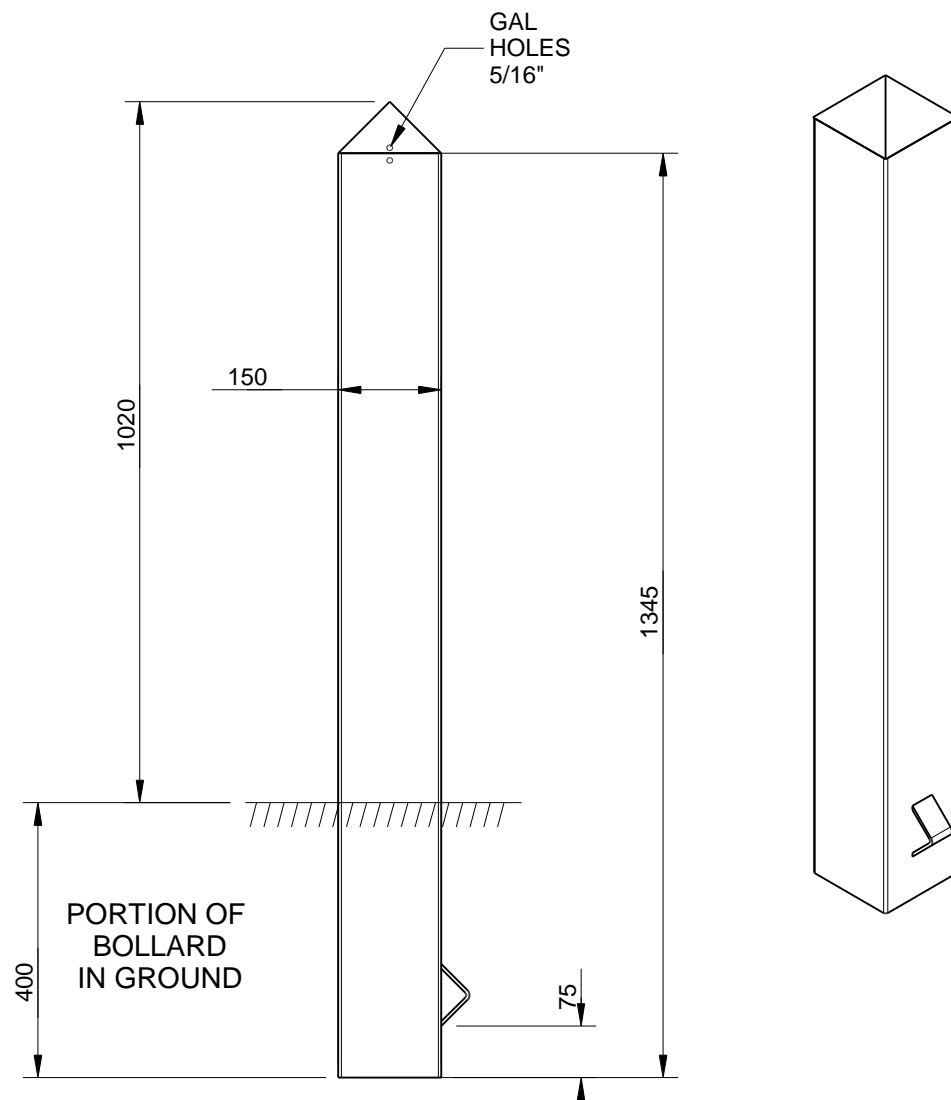

CONFIDENTIAL

REVISION	#	DESCRIPTION	BY	DATE	DRAWN	DRAWN DATE	CHECKED	CHECKED DATE	SCALE	A4
	1	ORIGINAL DRAWING	SJ	3.1.11	R.CRIGTON	6.1.14			N/A	
2	FULL PRODUCT REVIEW	RBC	6.1.14							
3										
4										
5										

GABLE TOP BOLLARD - IN GROUND  
SPEC.

FFSB008023

REV. 2

SHEET 1 OF 2

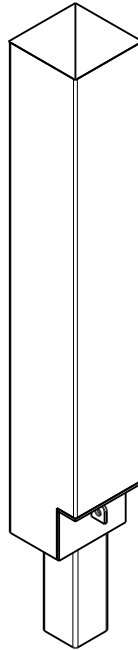
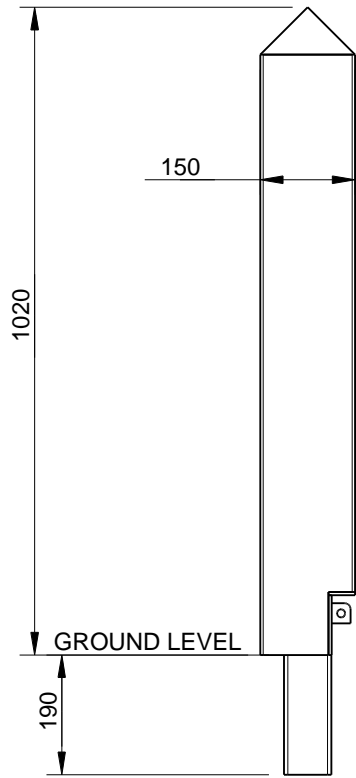
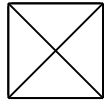

## SPECIFICATION:

**Material:**  
Mild steel

**Dimensions:**  
All in mm unless otherwise stated

**Finish:**  
Steel - Galvanised mild steel & optional powder coat

**Ground Fixings:**  
Removable.  
Attaches to in ground component (FFSB008036)



Quality  
ISO 9001  
SAI GLOBAL



CONFIDENTIAL

REVISION #	DESCRIPTION	BY	DATE	DRAWN	DRAWN DATE	CHECKED	CHECKED DATE	SCALE	A4
								N/A	
1	ORIGINAL DRAWING	RBC	6.1.14	R.CRIGTON	6.1.14				
2									
3									
4									
5									

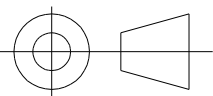

GABLE TOP BOLLARD - REMOVABLE  
SPEC.

FFSB008024

REV.  
1

SHEET  
1 OF 3

# REMOVABLE STAINLESS STEEL BOLLARD

FFSB008052 STANDARD BOLLARDS



4 SECTIONAL PERSPECTIVE  
@ A4

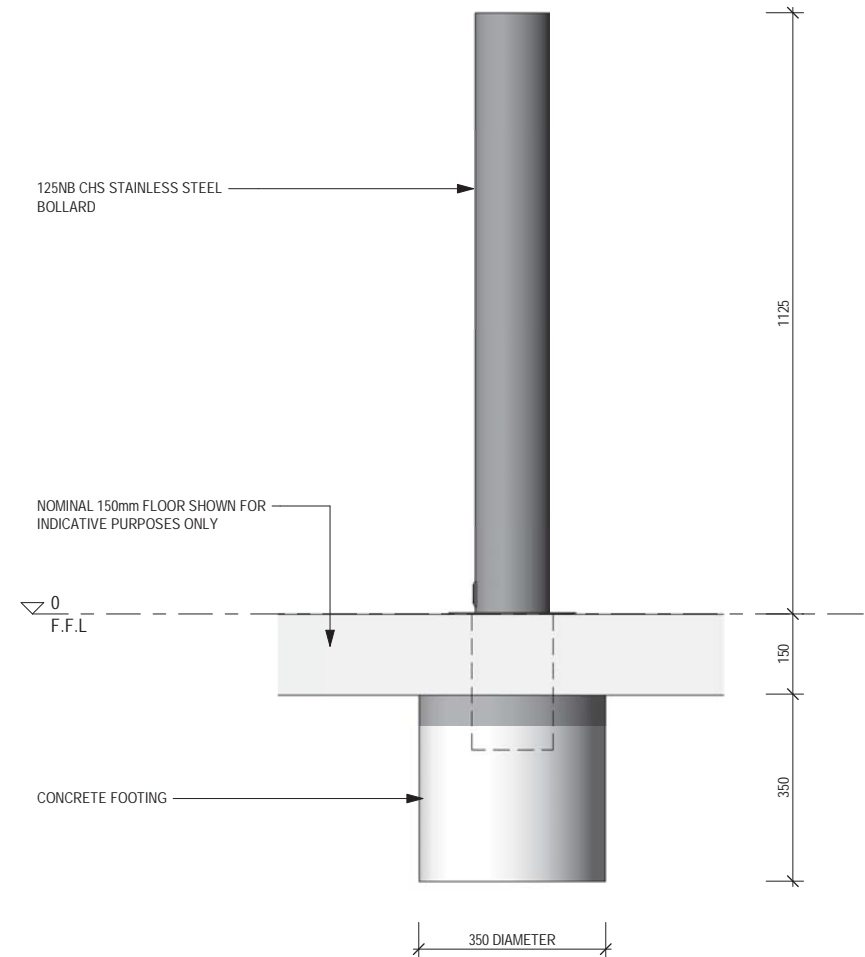

1 BOLLARD ELEVATION  
1 : 10 @ A4

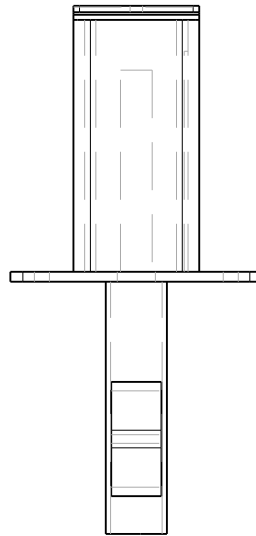
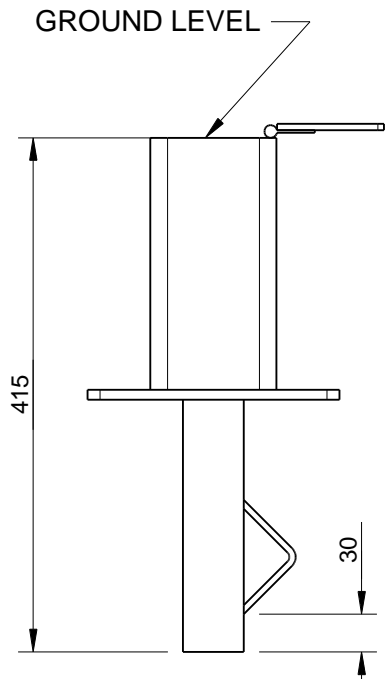
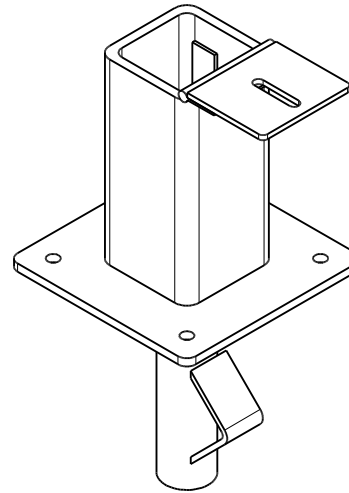
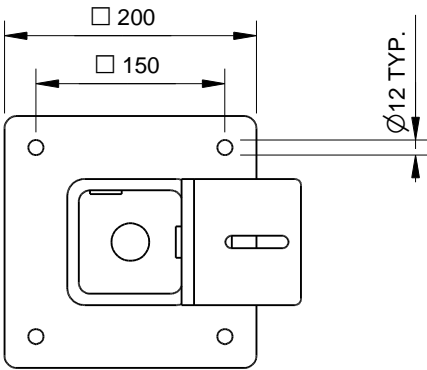

Quality  
ISO 9001  
SAI GLOBAL

## SPECIFICATION:

**Material:**  
Mild steel

**Dimensions:**  
All in mm unless otherwise stated

**Finish:**  
Galvanised and optional powder coat

**Ground Fixings:**  
In ground & Bolt down



CONFIDENTIAL

REVISION #	DESCRIPTION	BY	DATE	DRAWN	DRAWN DATE	CHECKED	CHECKED DATE	SCALE	
								A4	
1	ORIGINAL DRAWING	SJ	1.1.10	R.CRIGTON	18.12.13			N/A	
2	FULL PRODUCT REVIEW	RBC	18.12.13					REMOVABLE BOLLARD IN GROUND FIXTURE SPEC.	
3									
4									
5								FFSB008036	REV. 2 SHEET 1 OF 2

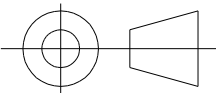

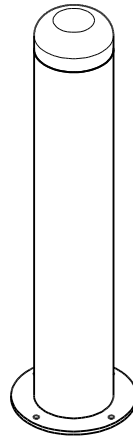
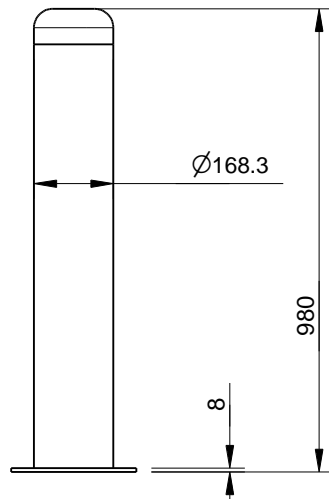
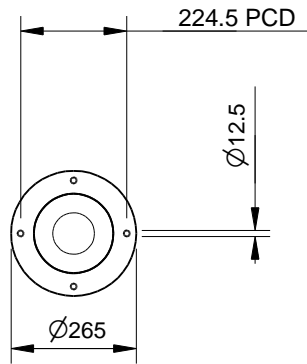

## SPECIFICATION:

**Material:**  
304 Stainless Steel

**Dimensions:**  
All in mm unless otherwise stated

**Finish:**  
Polished

**Ground Fixings:**  
Bolt down

Removable attachment available (FFSC008005)  
refer to FFSB008036 for details



Quality  
ISO 9001  
SAI GLOBAL



CONFIDENTIAL

REVISION #	DESCRIPTION	BY	DATE	DRAWN	DRAWN DATE	CHECKED	CHECKED DATE	SCALE	
								A4	
1	ORIGINAL DRAWING	SJ	3.1.11	R.CRIGTON	6.3.14			N/A	
2	FULL PRODUCT REVIEW	RBC	6.3.14			STAINLESS STEEL BOLLARD 150NB - BOLT DOWN SPEC. FFSC008003			
3									
4									
5									
								REV. 2	SHEET 1 OF 2

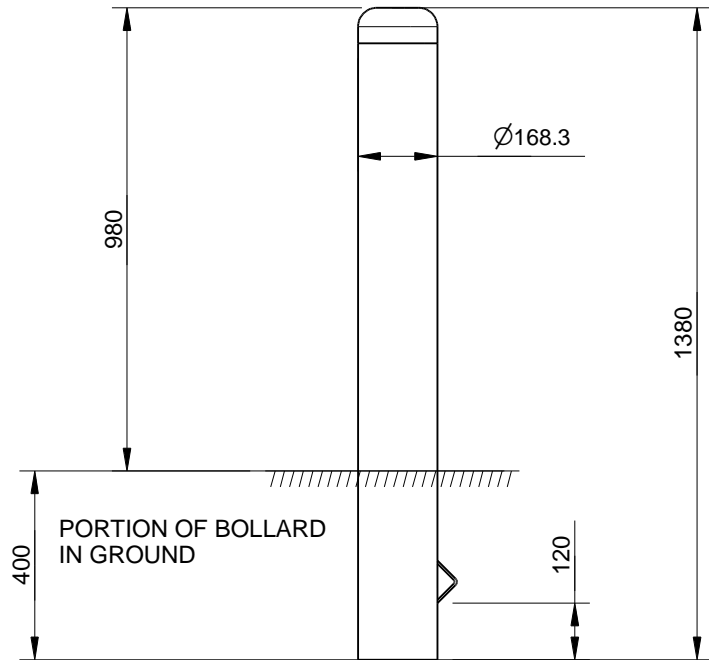
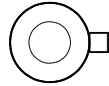

## SPECIFICATION:

**Material:**  
304 Stainless Steel

**Dimensions:**  
All in mm unless otherwise stated

**Finish:**  
Polished

**Ground Fixings:**  
In Ground

Removable attachment available (FFSC008005)  
refer to FFSD008036 for details



Quality  
ISO 9001  
SAI GLOBAL

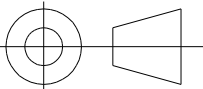

CONFIDENTIAL

REVISION #	DESCRIPTION	BY	DATE	DRAWN	DRAWN DATE	CHECKED	CHECKED DATE	SCALE	
								A4	
1	ORIGINAL DRAWING	SJ	3.1.11	R.CRIGTON	6.3.14			N/A	
2	FULL PRODUCT REVIEW	RBC	6.3.14						
3									
4									
5									
								STAINLESS STEEL BOLLARD 150NB - IN GROUND SPEC. FFSC008004	
									





Quality  
ISO 9001  
SAI GLOBAL

## SPECIFICATION:

**Material:**  
304 Stainless Steel

**Dimensions:**  
All in mm unless otherwise stated

**Finish:**  
Polished

**Ground Fixings:**  
Removable.  
Attaches to in ground component (FFSB008036)

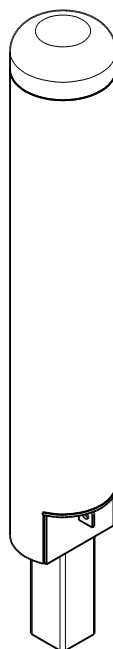
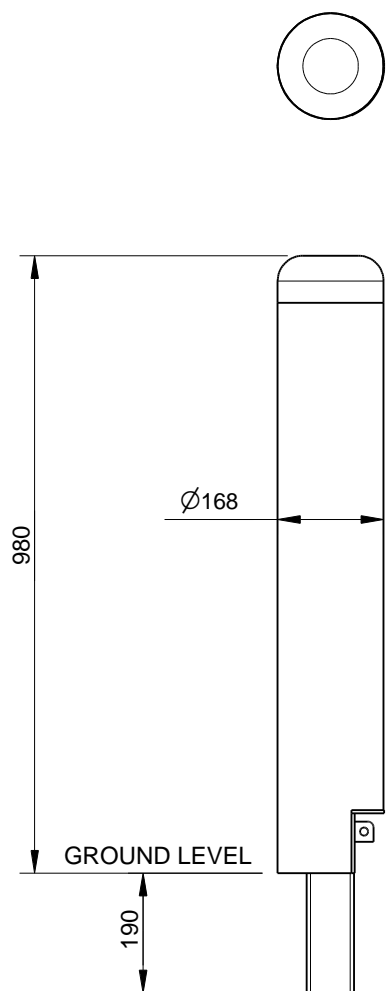

CONFIDENTIAL

REVISION	#	DESCRIPTION	BY	DATE	DRAWN	DRAWN DATE	CHECKED	CHECKED DATE	SCALE	A4
	1	1	ORIGINAL DRAWING	RBC	7.3.14	R.CRIGTON	7.3.14			
2	2									
3	3									
4	4									
5	5									

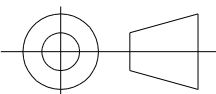

STAINLESS STEEL BOLLARD 150NB - REMOVABLE  
SPEC.

FFSC008005

REV.  
1

SHEET  
1 OF 3

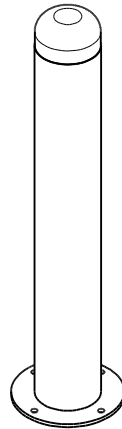
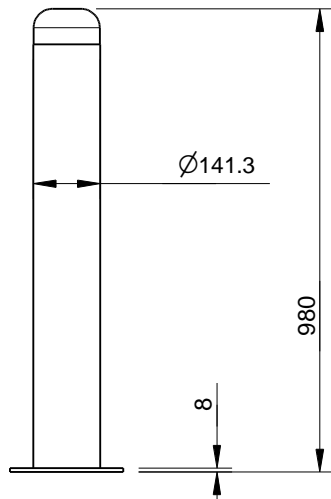
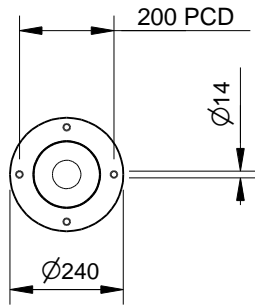

## SPECIFICATION:

**Material:**  
304 Stainless Steel

**Dimensions:**  
All in mm unless otherwise stated

**Finish:**  
Polished

**Ground Fixings:**  
Bolt down

Removable attachment available (FFSC008010)  
refer to FFSSB008036 for details



Quality  
ISO 9001  
SAI GLOBAL



CONFIDENTIAL

REVISION #	DESCRIPTION	BY	DATE	DRAWN	DRAWN DATE	CHECKED	CHECKED DATE	SCALE	A4
								N/A	
1	ORIGINAL DRAWING	SJ	3.1.11	R.CRIGTON	7.3.14				
2	FULL PRODUCT REVIEW	RBC	7.3.14						
3									
4									
5									

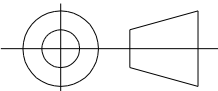

STAINLESS STEEL BOLLARD 125NB - BOLT DOWN SPEC.

FFSC008008

REV.  
2

SHEET  
1 OF 2

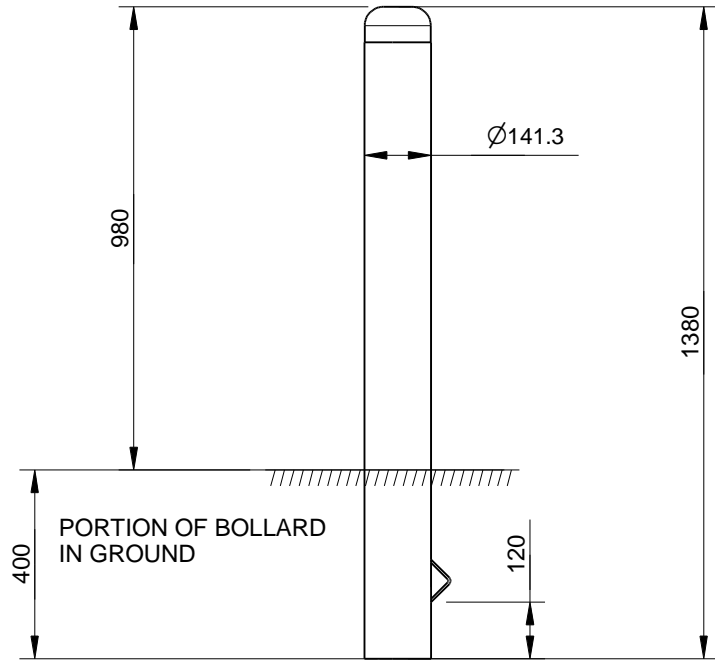

## SPECIFICATION:

**Material:**  
304 Stainless Steel

**Dimensions:**  
All in mm unless otherwise stated

**Finish:**  
Polished

**Ground Fixings:**  
In Ground

Removable attachment available (FFSC008010)  
refer to FFSC008036 for details



Quality  
ISO 9001  
SAI GLOBAL



CONFIDENTIAL

REVISION #	DESCRIPTION	BY	DATE	DRAWN	DRAWN DATE	CHECKED	CHECKED DATE	SCALE	
								A4	
1	ORIGINAL DRAWING	SJ	3.1.11	R.CRIGTON	7.3.14			N/A	
2	FULL PRODUCT REVIEW	RBC	7.3.14						
3									
4									
5									
							STAINLESS STEEL BOLLARD 125NB - IN GROUND SPEC.		
							FFSC008009	REV. 2	SHEET 1 OF 2



Quality  
ISO 9001  
SAI GLOBAL

## SPECIFICATION:

**Material:**  
304 Stainless Steel

**Dimensions:**  
All in mm unless otherwise stated

**Finish:**  
Polished

**Ground Fixings:**  
Removable.  
Attaches to in ground component (FFSB008036)

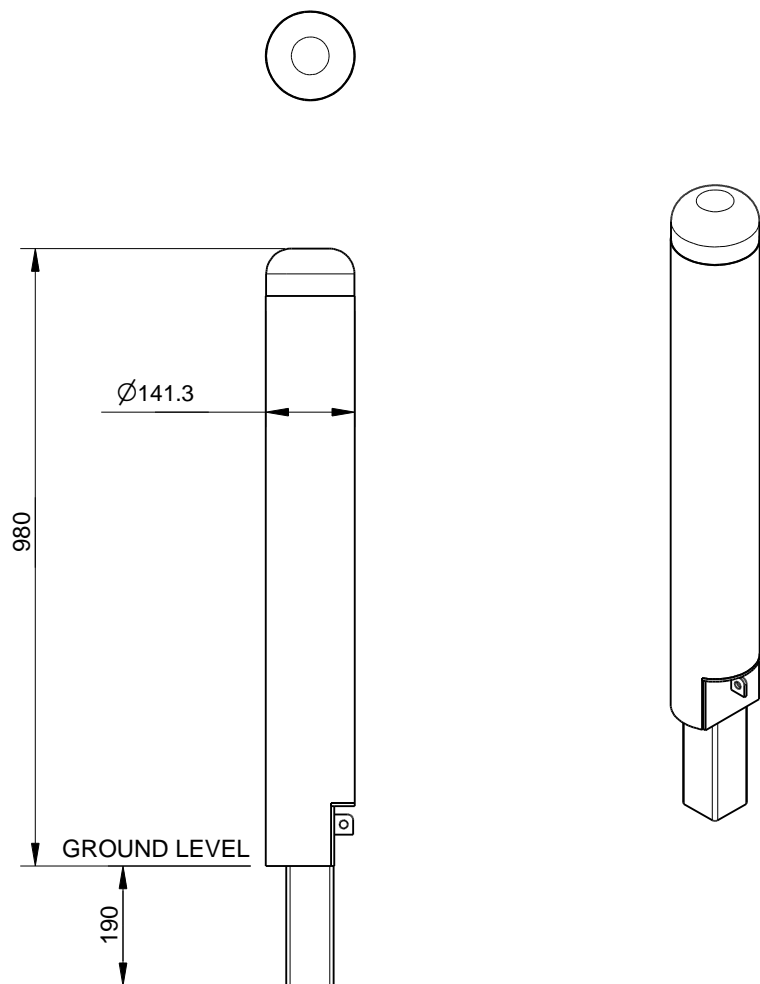

CONFIDENTIAL

REVISION	#	DESCRIPTION	BY	DATE	DRAWN	DRAWN DATE	CHECKED	CHECKED DATE	SCALE	A4
	1	1	ORIGINAL DRAWING	RBC	7.3.14	R.CRIGTON	7.3.14			
2	2									
3	3									
4	4									
5	5									

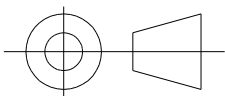

STAINLESS STEEL BOLLARD 125NB - REMOVABLE SPEC.

FFSC008010

REV. 1

SHEET 1 OF 3



Quality  
ISO 9001  
SAI GLOBAL

# SPECIFICATION:

**Material:**  
Column & base - Mild steel  
Cap - Recycled Aluminium

**Dimensions:**  
All in mm unless otherwise stated

**Finish:**  
Steel - Galvanised mild steel & optional powder coat  
Optional alternative coloured paint in recess.

**Ground Fixings:**  
Bolt down

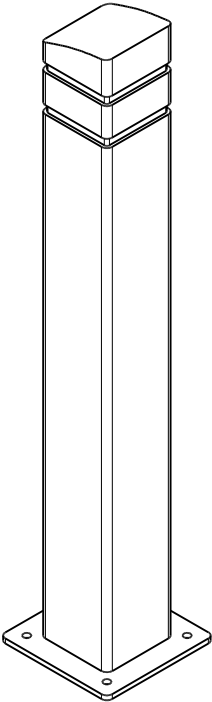
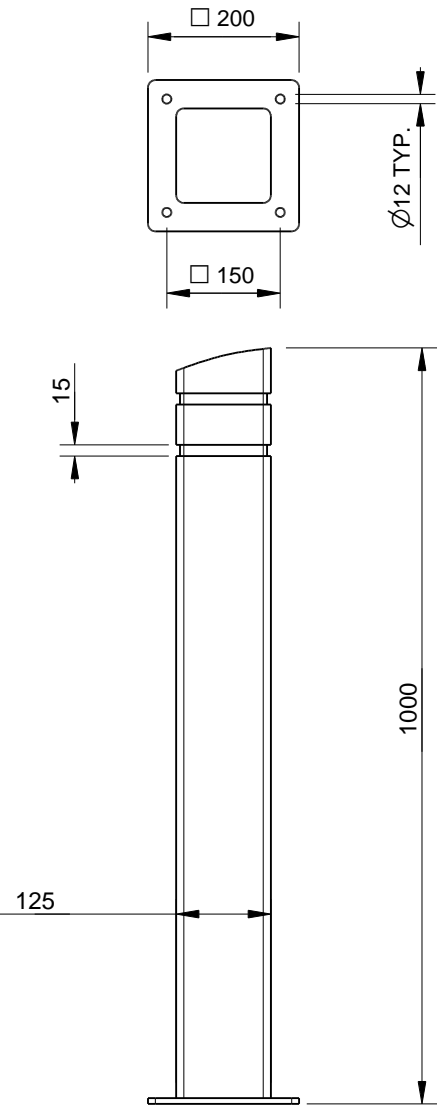

CONFIDENTIAL

REVISION #	DESCRIPTION	BY	DATE	DRAWN	DRAWN DATE	CHECKED	CHECKED DATE	SCALE	A4
								N/A	
1	ORIGINAL DRAWING	SJ	3.1.11	R.CRIGTON	7.1.14				
2	FULL PRODUCT REVIEW	RBC	7.1.14						
3									
4									
5									

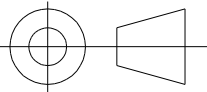

TRAVERSE BOLLARD - BOLT DOWN SPEC.

FFSB008033

REV. 2

SHEET 1 OF 2



Quality  
ISO 9001  
SAI GLOBAL

## SPECIFICATION:

### Material:

Column & base - Mild steel  
Cap - Recycled Aluminium

### Dimensions:

All in mm unless otherwise stated

### Finish:

Steel - Galvanised mild steel & optional powder coat  
Optional alternative coloured paint in recess.

### Ground Fixings:

In ground

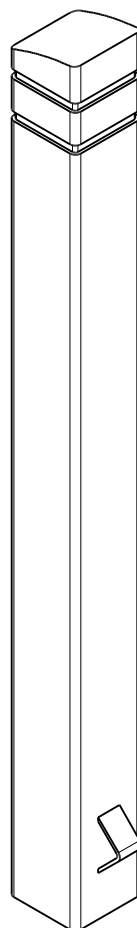
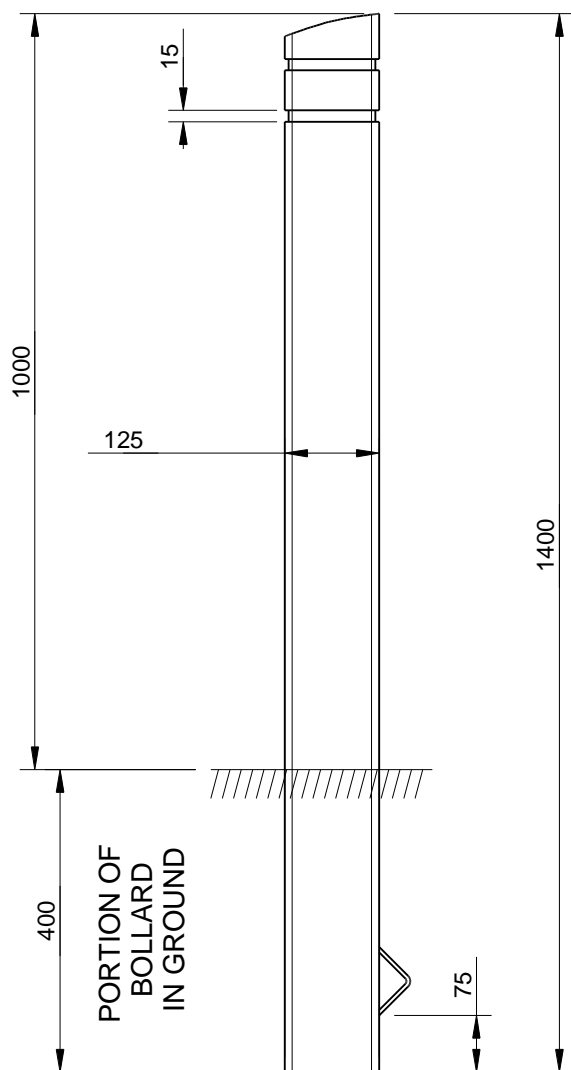

CONFIDENTIAL

REVISION #	DESCRIPTION	BY	DATE	DRAWN	DRAWN DATE	CHECKED	CHECKED DATE	SCALE		
								A4		
1	ORIGINAL DRAWING	SJ	3.1.11	R.CRIGTON	8.1.14			N/A		
2	FULL PRODUCT REVIEW	RBC	8.1.14					TRAVERSE BOLLARD - IN GROUND SPEC.		
3										
4										
5								FFSB008034	REV. 2	SHEET 1 OF 2

